

56 41 3133345
www.enersafe.cl



User Manual ESOL RTH-C

1kVA a 3kVA

All rights reserved.

The information in this document is subject to change without notice.

Publish statement

Thank you for purchasing this series UPS.

This series UPS is an intelligent, single phase in single phase out, high frequency online UPS designed by our R&D team who is with years of designing experiences on UPS. With excellent electrical performance, perfect intelligent monitoring and network functions, smart appearance, complying with EMC and safety standards, The UPS meets the world' s advanced level.

Read this manual carefully before installation

This manual provides technical support to the operator of the equipment.

Table of Contents

1. Important Safety Warning	2
1-1 Transportation	2
1-2 Preparation	2
1-3 Installation	2
1-4 Operation	3
1-5 Maintenance, service and faults	3
1-6 Symbols used in this guide	4
2. Installation and setup	5
2-1 Unpack checking	5
2-2 Real panel view	5
2-3 Installing the UPS	7
2-4 UPS start up and turn off	15
2-5 Configuring Battery Settings	16
2-6 LCD control panel	17
2-7 Setup the UPS	17
3. Operations	19
3-1 Button operation	19
3-2 LCD display	20
3-3 UPS setting	25
3-4 Operating Mode Description	27
3-5 Operational Status and Mode(s)	28
3-6 Alarm or Fault reference code	29
4. Troubleshooting	30
5. Storage and Maintenance	32
6. Options	32
7. Specification	34

1. Important Safety Warning

Important safety instructions – Save these instructions

Please comply with all warnings and operating instructions in this manual strictly. Save this manual properly and read carefully the following instructions before installing the unit. Do not operate this unit before reading through all safety information and operating instructions carefully

There exists dangerous voltage and high temperature inside the UPS. During the installation, operation and maintenance, please abide the local safety instructions and relative laws, otherwise it will result in personnel injury or equipment damage. Safety instructions in this manual act as a supplementary for the local safety instructions. Our company will not assume the liability that caused by disobeyingsafety instructions.

1-1 Transportation

- Please transport the UPS system only in the original package to protect against shock and impact.

1-2 Preparation

- Condensation may occur if the UPS system is moved directly from cold to warm environment. The UPS system must be absolutely dry before being installed. Please allow at least two hours for the UPS system to acclimate the environment.
- Do not install the UPS system near water or in moist environments.
- Do not install the UPS system where it would be exposed to direct sunlight or near heater.
- Do not block ventilation holes in the UPS housing.

1-3 Installation

- Do not connect appliances or devices which would overload the UPS system (e.g. laser printers) to the UPS output sockets.
- Place cables in such a way that no one can step on or trip over them.
- Do not connect domestic appliances such as hair dryers to UPS output sockets.
- The UPS can be operated by any individuals with no previous experience.
- Connect the UPS system only to an earthed shockproof outlet which must be easily accessible and close to the UPS system.

- Please use only VDE-tested, CE-marked mains cable (e.g. the mains cable of your computer) to connect the UPS system to the building wiring outlet (shockproof outlet).
- Please use only VDE-tested, CE-marked power cables to connect the loads to the UPS system.
- When installing the equipment, it should ensure that the sum of the leakage current of the UPS and the connected devices does not exceed 3.5mA.

1-4 Operation

- Do not disconnect the mains cable on the UPS system or the building wiring outlet (shockproof socket outlet) during operations since this would cancel the protective earthing of the UPS system and of all connected loads.
- The UPS system features its own, internal current source (batteries). The UPS output sockets or output terminals block may be electrically live even if the UPS system is not connected to the building wiring outlet.
- In order to fully disconnect the UPS system, first press the OFF/Enter button to disconnect the mains.
- Prevent no fluids or other foreign objects from inside of the UPS system.

1-5 Maintenance, service and faults

- The UPS system operates with hazardous voltages. Repairs may be carried out only by qualified maintenance personnel.
- **Caution** - risk of electric shock. Even after the unit is disconnected from the mains (building wiring outlet), components inside the UPS system are still connected to the battery and electrically live and dangerous.
- Before carrying out any kind of service and/or maintenance, disconnect the batteries and verify that no current is present and no hazardous voltage exists in the terminals of high capability capacitor such as BUS-capacitors.
- Only persons are adequately familiar with batteries and with the required precautionary measures may replace batteries and supervise operations. Unauthorized persons must be kept well away from the batteries.
- **Caution** - risk of electric shock. The battery circuit is not isolated from the input voltage. Hazardous voltages may occur between the battery terminals and the

ground. Before touching, please verify that no voltage is present!

- Batteries may cause electric shock and have a high short-circuit current. Please take the precautionary measures specified below and any other measures necessary when working with batteries:
 - remove wristwatches, rings and other metal objects
 - use only tools with insulated grips and handles.
- When changing batteries, install the same number and same type of batteries.
- Do not attempt to dispose of batteries by burning them. This could cause battery explosion.
- Do not open or destroy batteries. Escaping electrolyte can cause injury to the skin and eyes. It may be toxic.
- Please replace the fuse only with the same type and amperage in order to avoid fire hazards.
- Do not dismantle the UPS system.

1-6 Symbols used in this guide



WARNING!

Risiko electric shock



CAUTION!

Read this information to avoid equipment damage

2. Installation and setup

NOTE: Before installation, please inspect the unit. Be sure that nothing inside the package is damaged. Please keep the original package in a safe place for future use.

2-1 Unpack checking

- Don't lean the UPS when moving it out from the packaging.
- Check the appearance to see if the UPS is damaged or not during the transportation, do not switch on the UPS if any damage found. Please contact the dealer right away.
- Check the accessories according to the packing list and contact the dealer in case of missing parts.

It includes:

- (1) UPS user's guide
- (2) Software Suite CD
- (3) USB cable
- (4) Power cord (Input and output)
- (5) RS232 cable

2-2 Real panel view

1KVA(S/H):

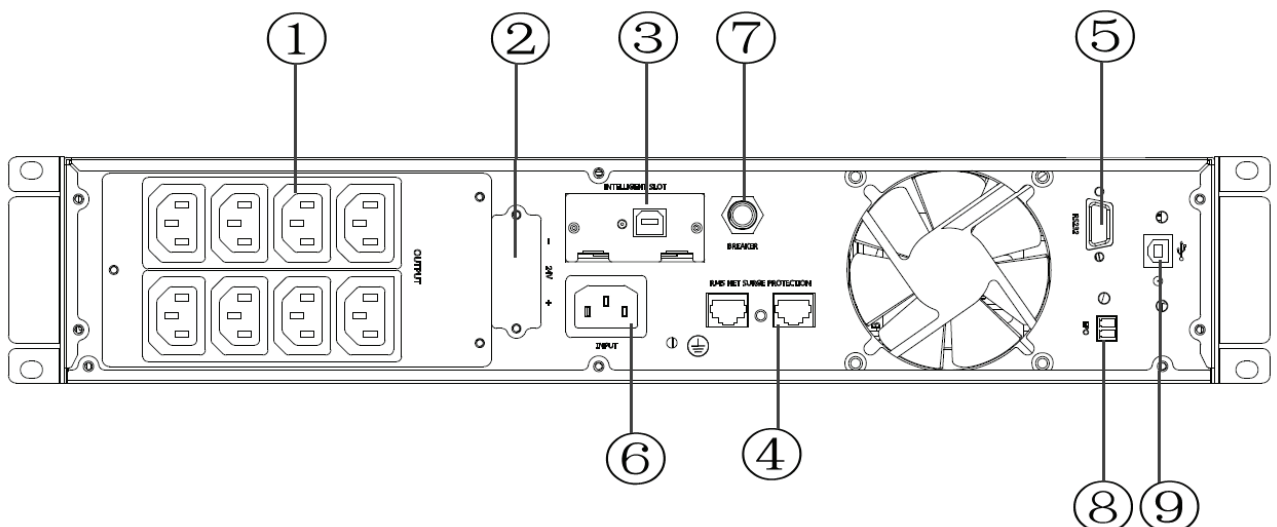

2KVA(S/H):

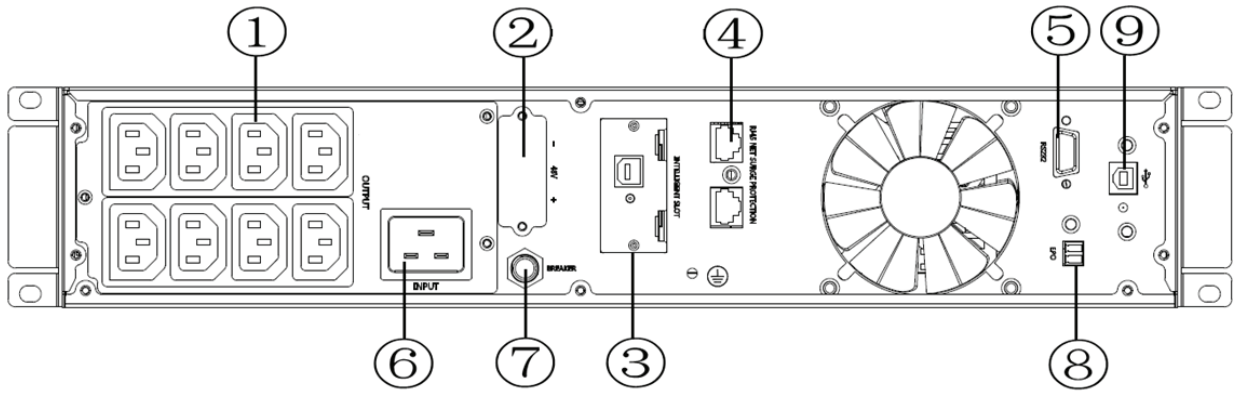

3KVA(S/H):

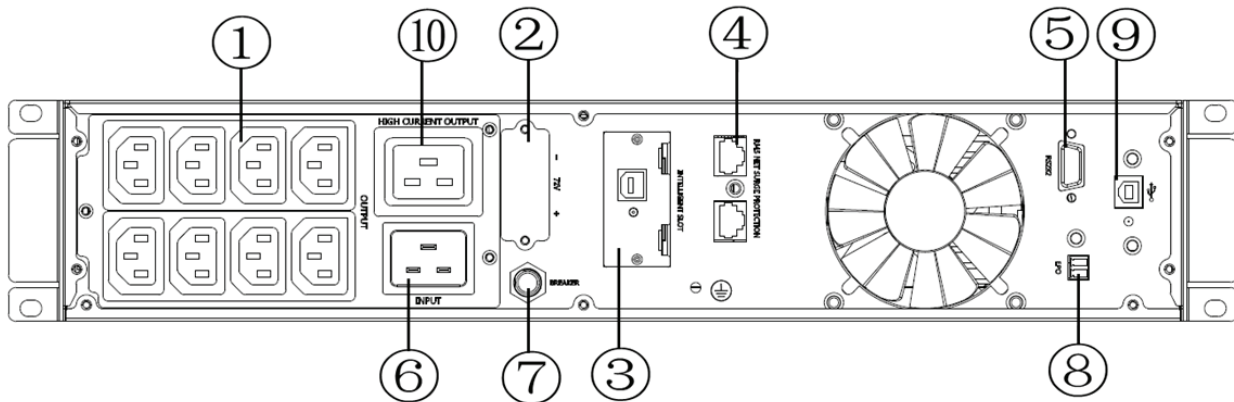

1. Output receptacles(10A)
2. Battery Terminal
3. SNMP intelligent slot (option)
4. Network /Fax/Modem Surge Protection(option)
5. RS-232 communication port
6. AC input receptacle
7. Input circuit breaker
8. EPO(option)
9. USB(option)
10. Output receptacle(16A)

2-3 Installing the UPS

● Rackmount installation

The Rackmount cabinet comes with all of the hardware required for installation in a standard EIA or JIS seismic Rackmount configuration with square and round mounting holes. The rail assemblies adjust to mount in 19" racks with a distance from front to rear around 70~76 cm (27 to 30 inches) deep.

CAUTION



- *The cabinet is heavy. Removing the cabinet from its carton requires a minimum of two people.*
- *If installing optional EBP(S), make sure to install the EBP(S) directly below the UPS so that all wiring between the cabinets is installed behind the front covers and inaccessible to users.*

NOTE *Mounting rails are required for each individual cabinet*

(1) To install the rail kit

- a) Assemble the left and right rails to the rear rails as shown in Figure 1. Do not tighten the screws.

Adjust each rail size for the depth of your rack.

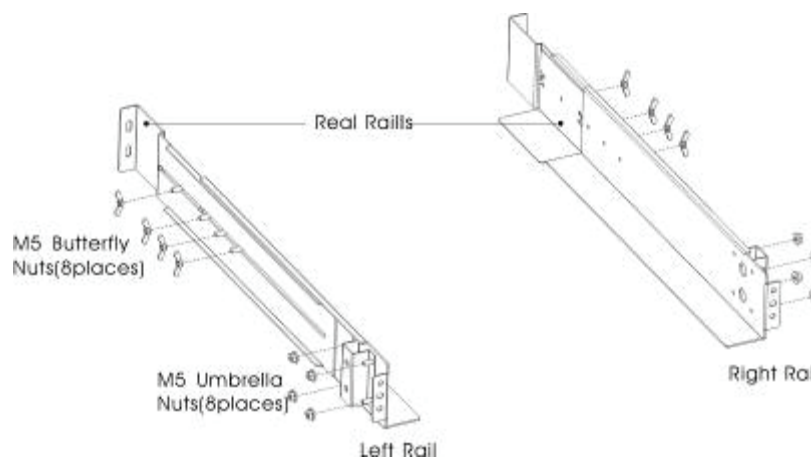

Figure 1 Securing the Rails

- b) Select the proper size in the rack for positioning the UPS (see Figure 2). The rail occupies four positions on the front and rear of the rack.
- c) Tighten four M5 Umbrella Nuts in the side of rail assembly (see Figure 1).
- d) Fix one rail assembly to the front of the rack with one M5×12 pan-head screw and one M5 cage nut. Using two M5 cage nuts and two M5×12 pan-head screws, to fix the rail assembly to the rear of the rack.

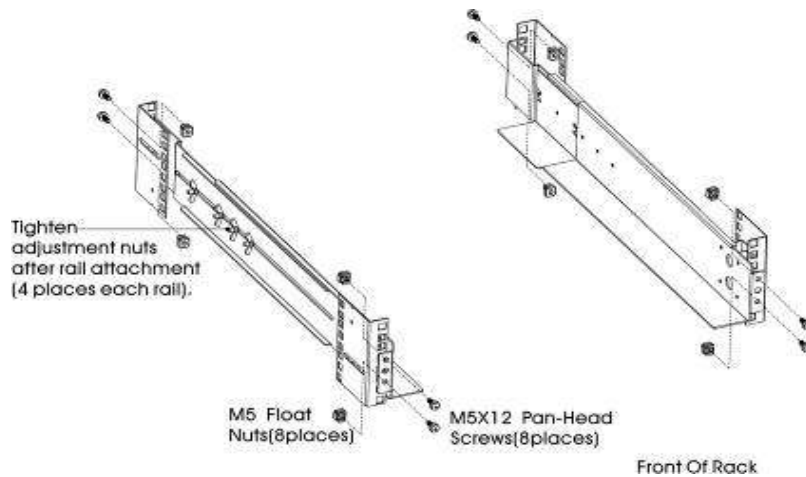

Figure 2 Fixing the Rails

- e) Repeat Steps 3 and 4 for the other rail assembly.
- f) Tighten the four butterfly nuts in the middle of each rail assembly.
- g) If installing optional cabinets, repeat Step 1 through Step 6 for each rail kit.
- h) Place the UPS on a flat, stable surface with the front of the cabinet facing to you.
- i) Align the mounting brackets with the screw holes on each side of the UPS and fix with the supplied M4×8 flat-head screws(see Figure 3)

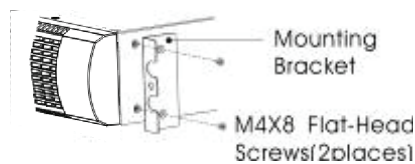

Figure 3 Installing the Mounting Brackets

- j) If installing optional cabinets, repeat Step 8 and 9 for each cabinet.
- k) Slide the UPS and any other optional cabinets into the rack.
- l) Secure the front of the UPS to the rack using one M5×12 pan-head screws and one M5 cage nuts on each side(see Figure 4).Install the bottom screw on each side through the bottom hole of mounting bracket and the bottom hole of the rail.

Repeat for any optional cabinets.

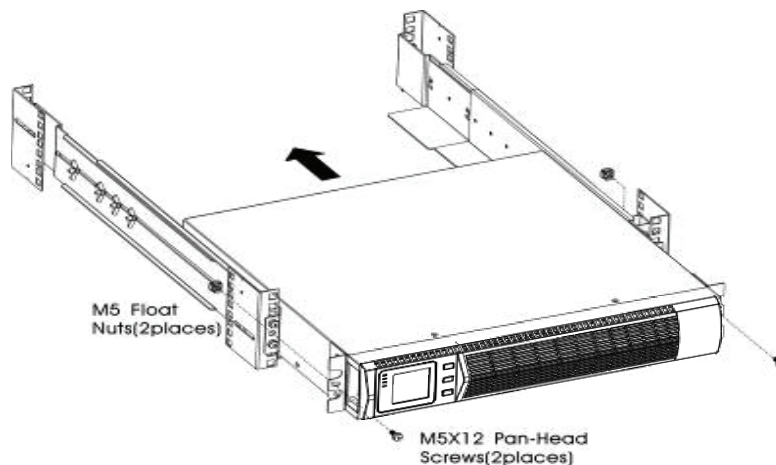

Figure 4 Securing the Front of the Cabinet

- m) Continue to the following section, "Rackmount Wiring Installation."

(2) Rackmount Wiring Installation

- a) Installing the UPS, including connecting the UPS internal batteries
- b) Connecting any Optional EBP(S)

● To install the UPS

NOTE Do not make unauthorized changes to the ups; otherwise, damage may occur to your equipment and void your warranty.

NOTE Do not connect the ups power cord to utility until after installation is completed.

- a) Remove the front cover of each UPS

Press the cover side with LCD display, hold the other side and quickly extract it, then extract the other side with display. (see Fig.5)

NOTE A ribbon cable connects the LCD control cover to the UPS. Do not pull on the cable or disconnect it.

When remove the cover, Operate as the following right Figure shows instead of the left one. (see Fig.5)

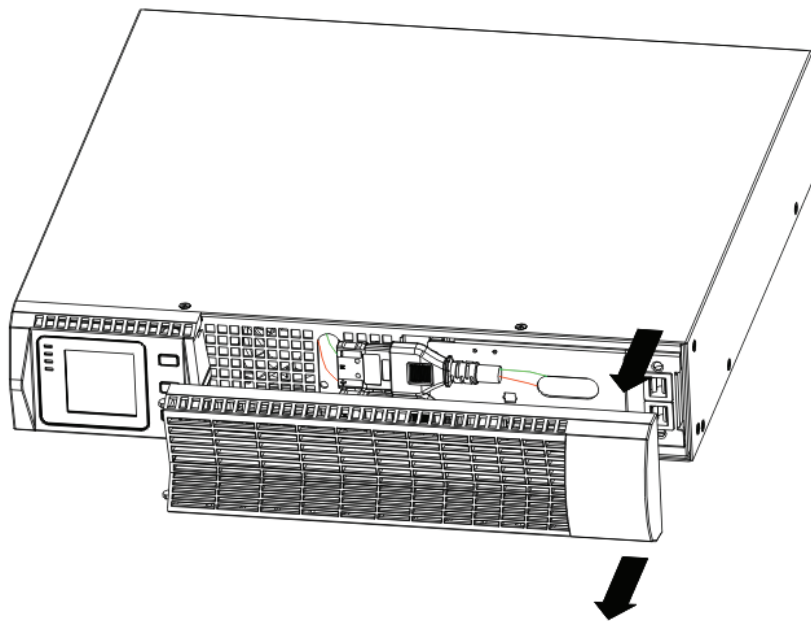

Figure 5 Extract UPS front cover

CAUTION



A small amount of arcing may occur when connecting the internal batteries. This is normal and will not harm personnel. Connect the cables quickly and firmly

- b) Connect the internal battery connector (see Figure6)

Connect red to red, Press the connector tightly together to ensure a proper connection.

- c) If you are installing EBPS, see the following section, "Connecting the EBP(s)," before continuing with the UPS installation.

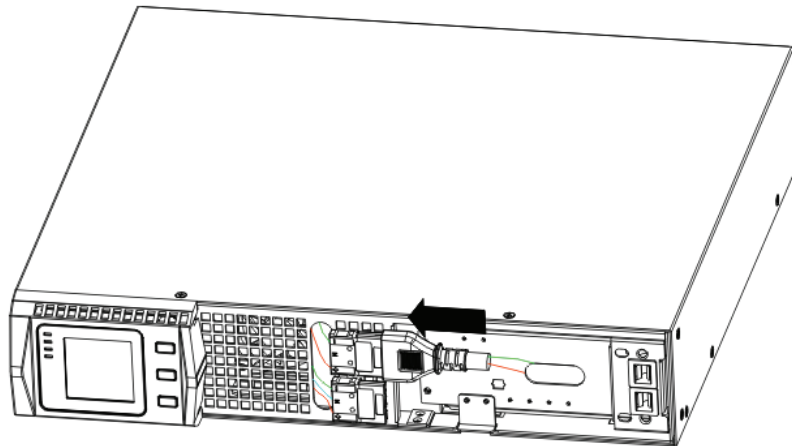

Figure 6 Connecting the UPS Internal Batteries

- d) Replace the UPS front cover.

To replace the cover, verify that the ribbon cable is protected and (if EBPS are installed) the EBP cable is routed through the knockout on the bottom of the cover.

Put the front cover hooks of side with display to the cover port, put another side to the other two ports, then press it until the cover and the chassis are combined tightly.

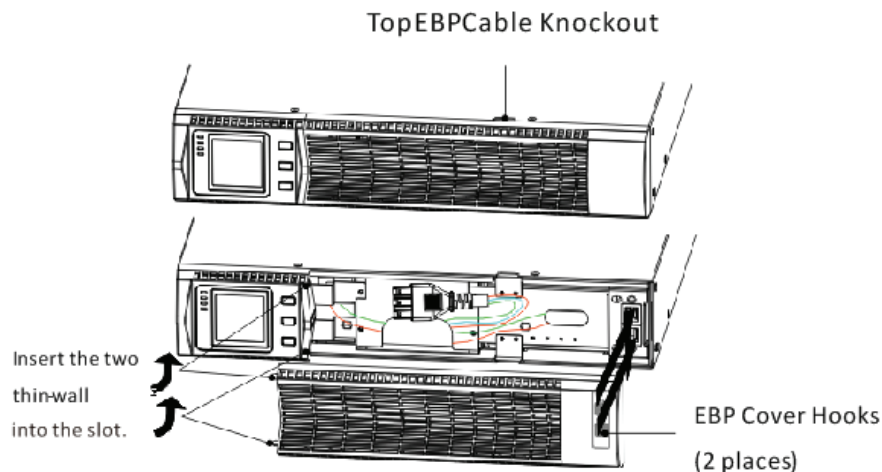

Figure 7

- e) If you are installing power management software, connect your computer to one of the communication ports or optional connectivity card. For the communication ports, use an appropriate cable.
- f) If your rack has conductors for grounding or bonding of ungrounded metal parts, connect the ground cable (not supplied) to the ground bonding screw. See "Rear Covers" for the location of the ground bonding screw for each model.

- g) If an emergency power-off (disconnect) switch is required by local codes, see “Remote Emergency Power-off” (REPO) to install the REPO switch before powering on the UPS.
- h) Continue to “UPS Start up” .

● **Connecting the EBP(s)**

(1) To install the optional EBP(s) for a UPS

a) Remove the front cover of each EBP and UPS (see Figure 8).

It is the same with the installation of the front cover. (Refer” To install the UPS ”)

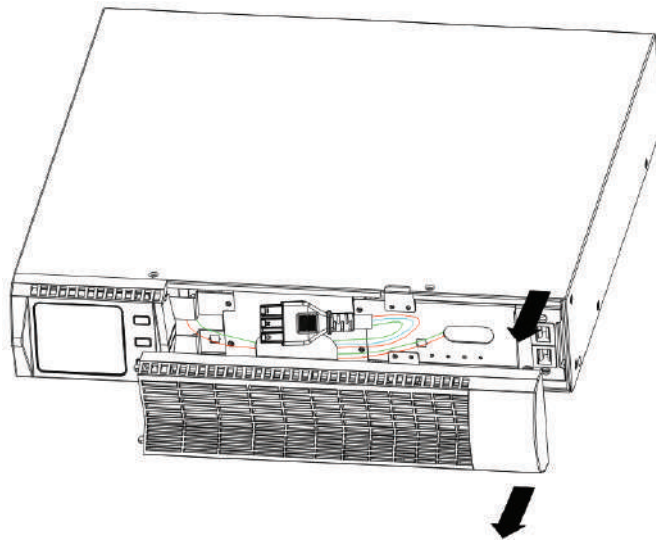

Figure 8 Removing the EBP Front Cover

b) On the bottom of the UPS front cover, remove the EBP cable knockout (see Figure 9).

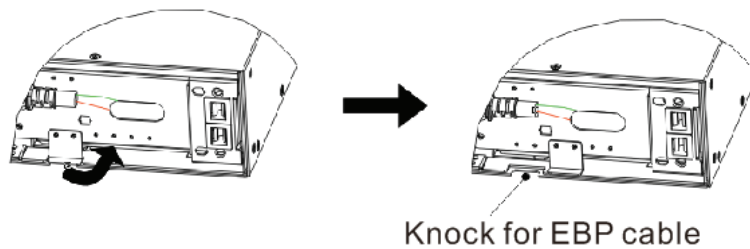

Figure 9 Removing the UPS Cable Knockout

- c) For the bottom (or only) EBP, remove the EBP cable knockout on the top of the EBP front cover. See Figure 10 for the location of the top EBP cable knockout.
- d) If you are installing more than one EBP, for each additional EBP remove the EBP cable knockout on the top and bottom of the EBP front cover. See Figure 10 for the location of the EBP cable knockouts.

CAUTION



A small amount of arcing may occur when connecting an EBP to the UPS. This is normal and will not harm personnel. Insert the EBP cable into the UPS battery connector quickly and firmly.

- e) Plug the EBP cable(s) into the battery connector(s) as shown in Figure 10. Up to four EBPS may be connected to the UPS. Connect black to black,. Press the connector tightly together to ensure a proper connection.

To connect a second EBP, unclip the EBP connector on the first EBP and pull gently to extend the wiring to the EBP connector on the second EBP. Repeat for any additional EBPs.

- f) Verify that the EBP connections are tight and the adequate bend radius and strain relief exist for each cable.

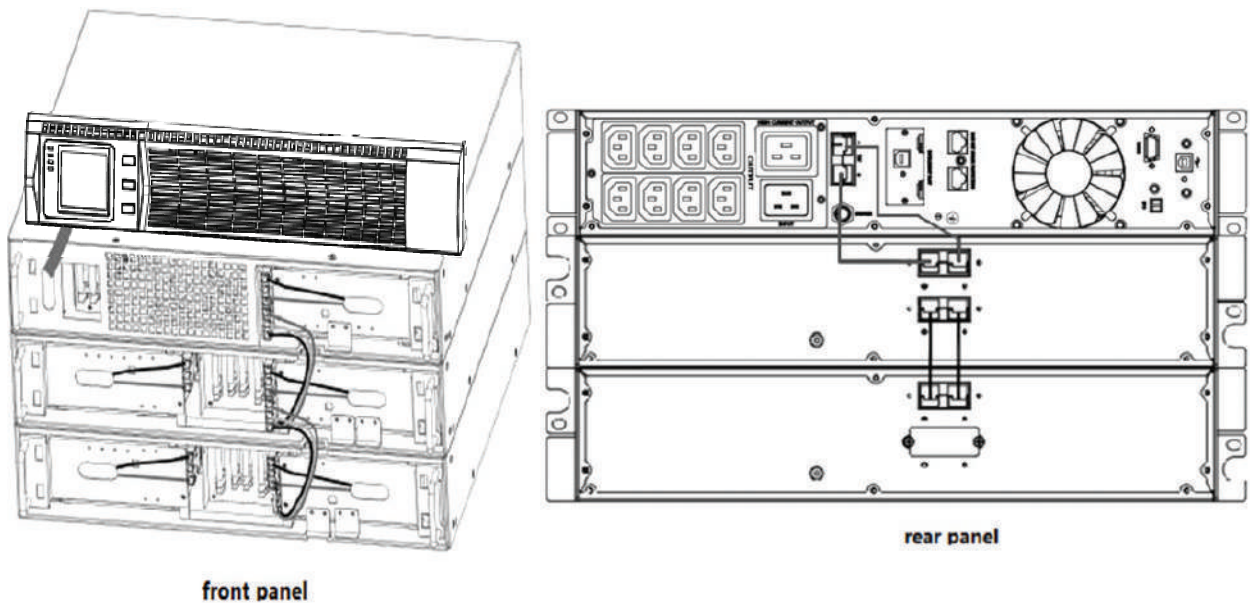

Figure 10 Typical EBP Installation

- g) Replace the EBP front cover.

To replace the cover, verify that the EBP cables are routed through the EBP cover knockouts, cover connects with the cover hook near the left side of the EBP cabinet. Repeat for each additional EBP.

It is the same with the installation of the front cover. (Refer" to install the UPS")

- h) Verify that all wires connected between the UPS and EBP(s) are installed behind the front covers and not accessible to users.
- i) Return to Step4 to continue the UPS installation.

● Rackmount converted to Tower Installation

(1) Rackmount converted to Tower plastic base installation

- ① Two plastic base brackets
- ② Flatten it after intercrossing

Intercross as following Figure:

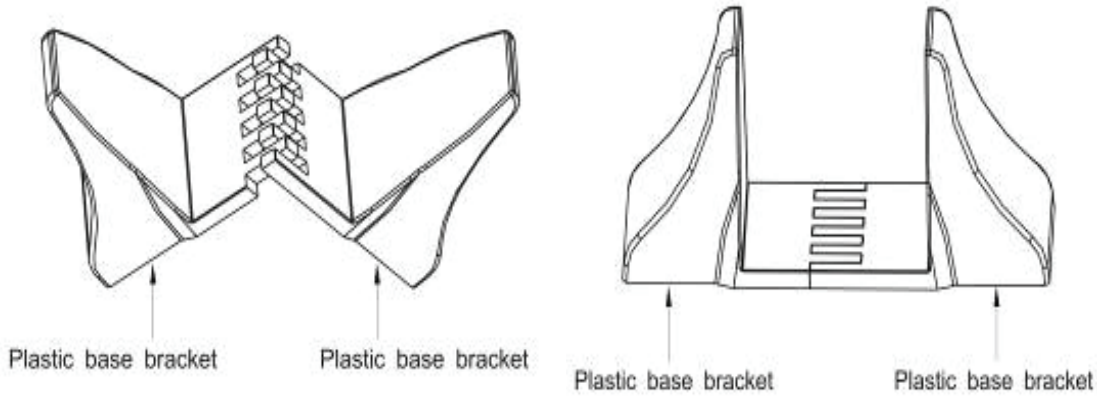
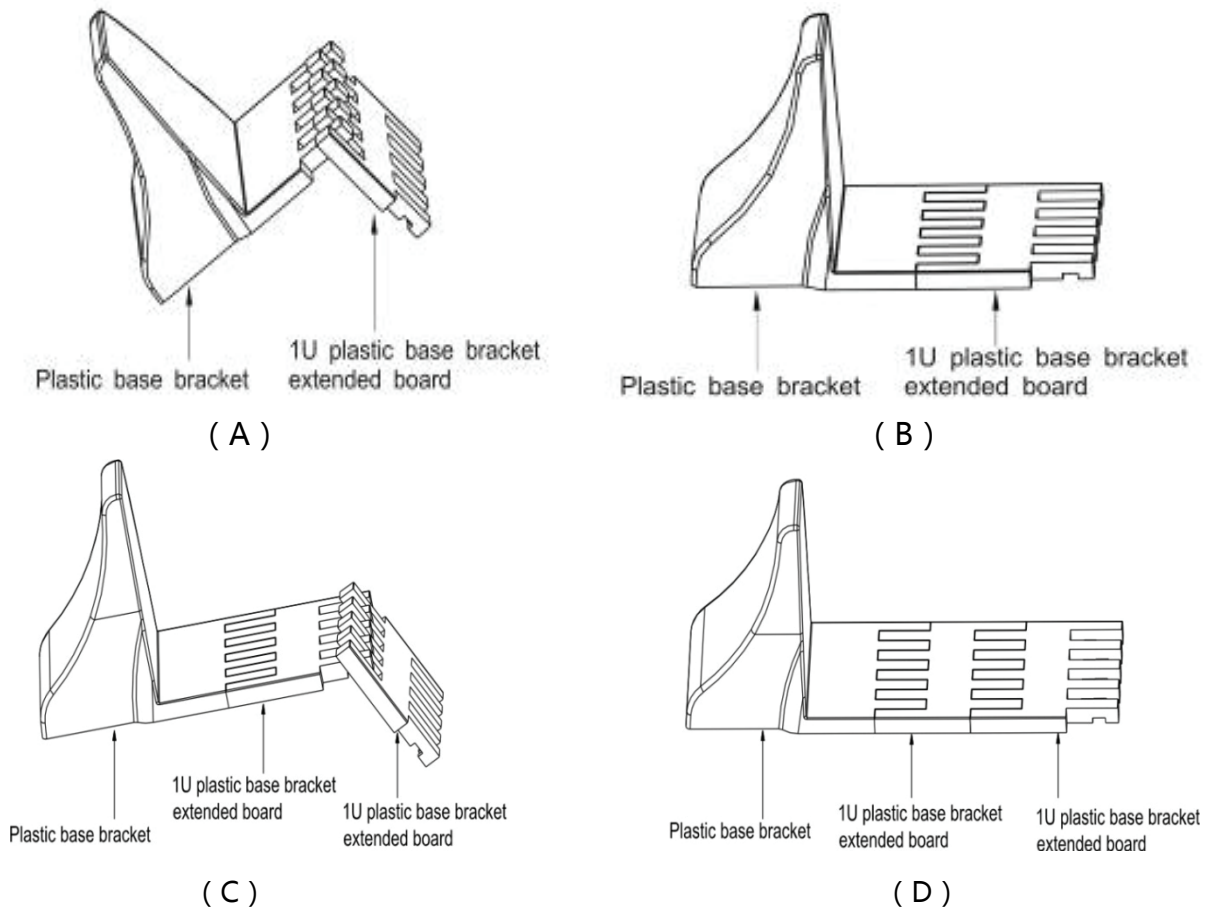

Figure 11 plastic base installation

③If an EBP is needed to be placed in the middle, the assembly of plastic base is similar (Figure 11).The difference is that two 1U plastic base extended boards are added in the middle.(as the following shows)



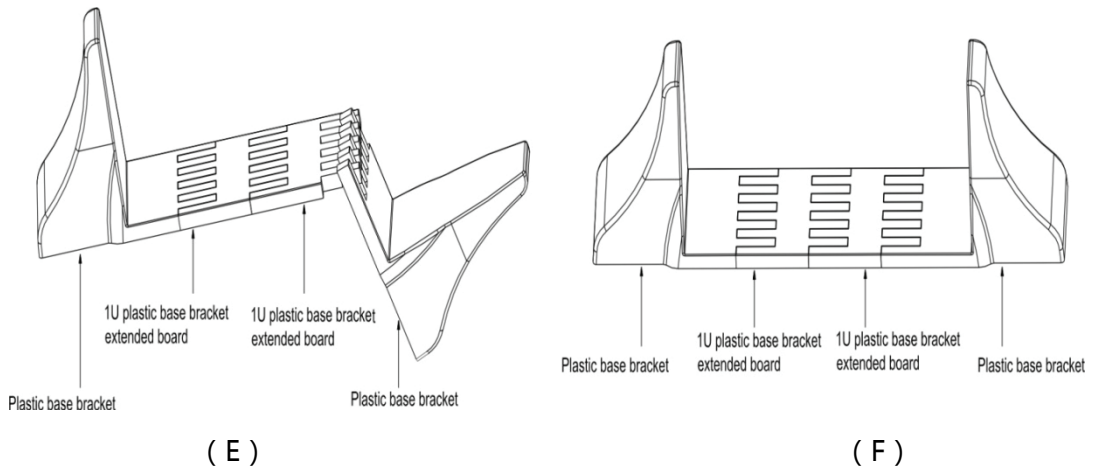

Figure 12 increase EBP plastic base installation

- The installation between UPS and EBPS can be referred to Fig.13

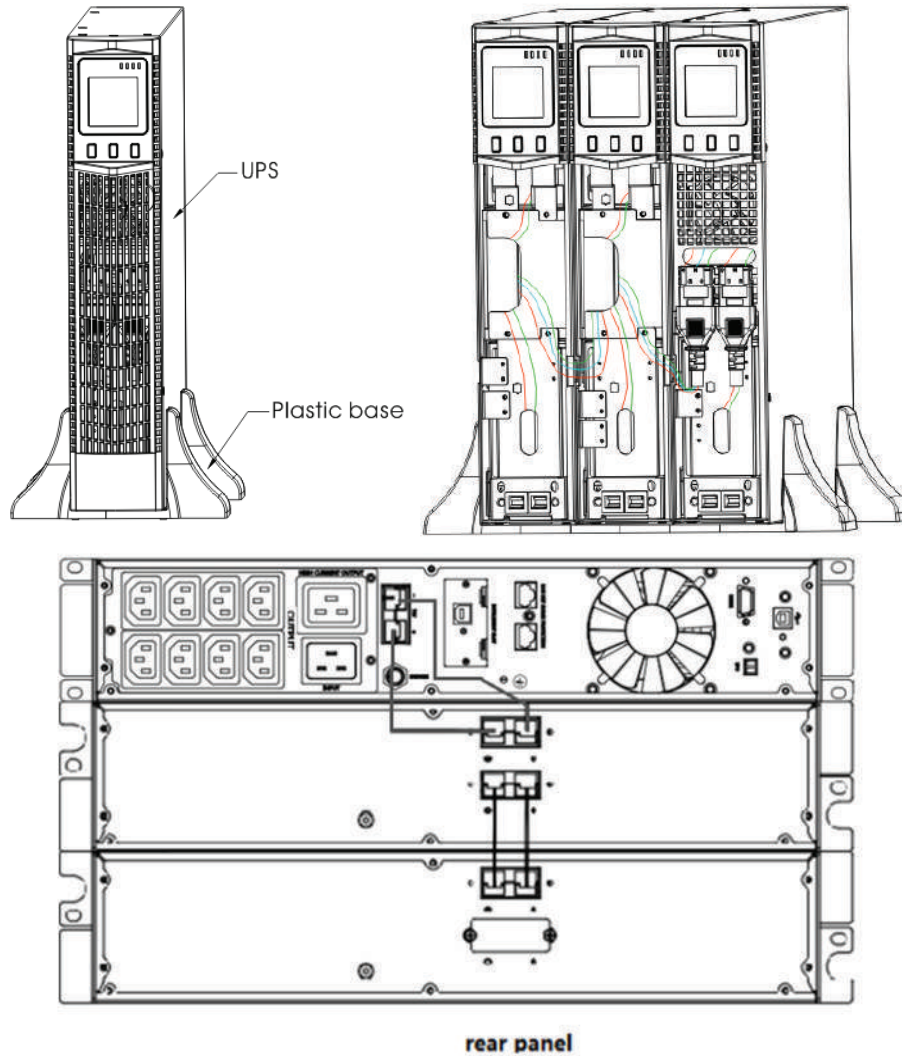

Figure 13 The installation for UPS and battery box

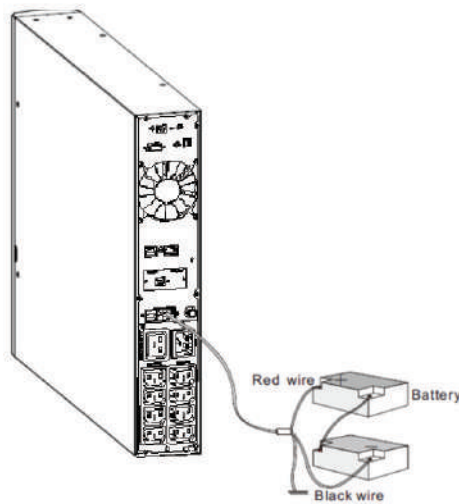

Figure 14 Long backup external battery connection

- a) Install the base, then place the RT UPS on the base one by one as Fig.13 shows.
- b) The cover installation and cable connection of the UPS and EBPS are the same as RT. (To install the optional EBP(s) for a UPS)

2-4 UPS start up and turn off

● Start up operation

- (1) Turn on the UPS in line mode

NOTE Verify that the total equipment ratings do not exceed the UPS capacity to prevent an overload alarm.

- a) Once mains power is plugged in, the UPS will charge the battery, at the moment, the LCD shows that the output voltage is 220, which means the UPS automatically start the inverter. If it is expected to change to bypass model, you can Press "OFF" key.
 - b) Press and hold the ON key for more than half a second to start the UPS, then it will start the inverter.
 - c) Once started, the UPS will perform a self-test function, LED will light and go out circularly and orderly. When the self-test finishes, it will come to line mode, the corresponding LED lights, the UPS is working in line mode.
- (2) Turn on the UPS by DC without mains power
 - a) When mains power is disconnected, press and hold the ON key for more than half a second to start UPS.
 - b) The operation of the UPS in the process of start is almost the same as that when

mains power is in. After finishing the self-test, the corresponding LED lights and the UPS is working in battery mode.

- **Turn off operation**

(1) Turn off the UPS in line mode

- a) Press and hold the OFF key for more than half a second to turn off the UPS and inverter.
- b) After the UPS shutdown, the LEDs go out and there is no output. If output is needed, you can set bps "ON" on the LCD setting menu.

(2) Turn off the UPS by DC without mains power

- a) Press and hold the OFF key for more than half a second to turn off the UPS.
- b) When turning off the UPS, it will do self-testing firstly. The LEDs light and go out circularly and orderly until there is no display on the cover.

2-5 Configuring Battery Settings

- **Set the UPS for the number of EBPs installed.**

To ensure maximum battery runtime, configure the UPS for the correct number of EBPs, refer to Table 8 for the appropriate setting of battery numbers and type. Use the up and down scroll keys to select the number of battery strings according to your UPS configuration:



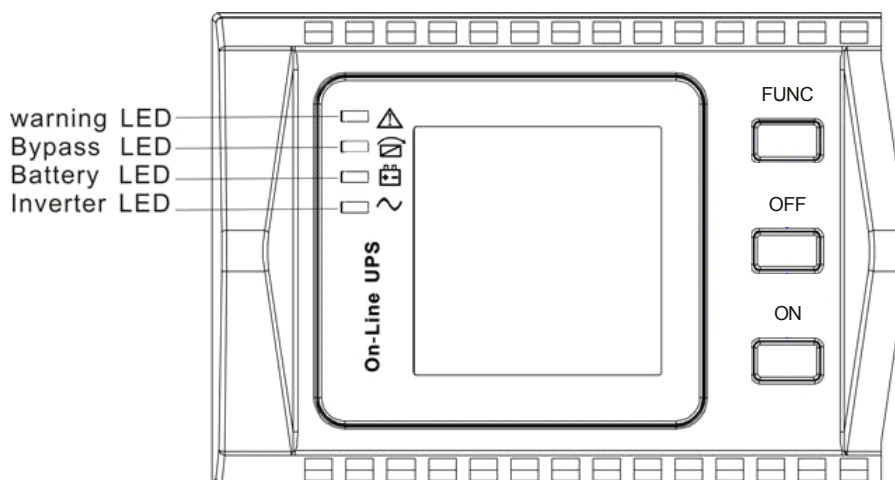

All UPS and EBP Cabinets	Number of BatteryStrings
UPS only (internal batteries)	1 (default)
UPS+1EBP	3
UPS+2EBPs	5
UPS+3EBPs	7
UPS+4EBPs	9
NOTE The UPS contains one battery string; each EBP contains two battery strings.	

2-6 LCD control panel



LCD control panel introduction

- (1) LED (from top to bottom: "alarm" , "bypass" , "battery" , "inverter");
 (2) On-Line UPS LCD display; (3) Buttons-FUNC button/OFF button/On button.

Indicator	Status	Description
 Red	On	The UPS has an active alarm or fault.
 Yellow	On	The UPS is in Bypass mode. The UPS is operating normally on bypass during High Efficiency operation.
 Yellow	On	The UPS is on Battery mode.
 Green	On	The UPS is operating normally on Oline.
NOTE When power on or startup , these indicators will turn on and off sequentially.		
NOTE On different operation modes , these indicators will indicate differently.		

2-7 Setup the UPS

Step 1: UPS input connection

Plug the UPS into a two-pole, three-wire, grounded receptacle only. Avoid using extension cords.

- For 200/208/220/230/240VAC models: The power cord is supplied in the UPS package.

Step 2: UPS output connection

- For socket-type outputs, simply connect devices to the outlets.
- For terminal-type input or outputs, please follow below steps for the wiring configuration:
 - a) Remove the small cover of the terminal block
 - b) Suggest using AWG14 or 2.1mm² power cords for 3KVA (200/208/220/230/240VAC models).
 - c) Upon completion of the wiring configuration, please check whether the wires are securely affixed.
 - d) Put the small cover back to the rear panel.

Step 3: Communication connection

Communication port:

USB port



RS-232 port

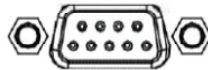

Intelligent slot



To allow for unattended UPS shutdown/start-up and status monitoring, connect the communication cable one end to the USB/RS-232 port and the other to the communication port of your PC. With the monitoring software installed, you can schedule UPS shutdown/start-up and monitor UPS status through PC.

The UPS is equipped with intelligent slot perfect for either SNMP or Relay card. When installing either SNMP or Relay card in the UPS, it will provide advanced communication and monitoring options.

NOTE: USB port and RS-232 port can't work at the same time.

Step 4: Turn on the UPS

Press the ON button on the front panel for two seconds to power on the UPS.



Note: The battery charges fully during the first five hours of normal operation. Do not expect full battery run capability during this initial charge period.



Step 5: Install software

For optimal computer system protection, install UPS monitoring software to fully configure UPS shutdown. You may insert provided CD into CD-ROM to install the monitoring software.

3. Operations

3-1 Button operation

Button	Function
ON Button 	<ul style="list-style-type: none"> ➤ Turn on the UPS: Press and hold ON button for at least 2 seconds to turn on the UPS. ➤ Choosing different value: When the UPS enters the setting mode, press this button to choose the different value what you want. ➤ Out off bypass mode : when the UPS enter to bypass mode, press and hold this button it will switch to normal mode.
OFF Button 	<ul style="list-style-type: none"> ➤ Turn off the UPS: Press and hold this button at least 2 seconds to turn off the UPS in battery mode. UPS will be in standby mode under power normal or transfer to Bypass mode if the Bypass enable setting by pressing this button. ➤ Down key: Press this button to display next selection in UPS setting mode. ➤ Exit setting mode: Press this button to confirm selection and exit setting mode when LCD display the last selection in UPS setting mode. ➤ Switch to bypass mode: When the main power is normal, press this button in 1 seconds. Then UPS will enter to bypass mode. This action will be ineffective when the input voltage is out of acceptable range.
FUNC/Rotate/Mute Button 	<ul style="list-style-type: none"> ➤ Switch LCD message: Press this button to change the LCD message for input voltage, input frequency, battery voltage, output voltage and output frequency etc. ➤ Rotate Key: After the UPS turn on, continue to press the button for 10 seconds and then the LCD screen begin to rotate. Again and it will be return! ➤ Mute the alarm: When the UPS is on battery mode, press and hold this button for at least 5 seconds to disable or enable the alarm system. But it' s not applied to the situations when warnings or errors occur. ➤ Up key: Press this button to display previous selection in UPS setting mode.



	<ul style="list-style-type: none"> ➤ Switch to UPS self-test mode: Press and hold this button for 2 seconds to enter UPS self-testing while in AC mode.
FUNC + OFF Button ( + )	<ul style="list-style-type: none"> ➤ Setting mode: Press and hold these buttons in the same moment for 5 seconds to enter UPS setting mode.

3-2 LCD display

Part one: Rack display

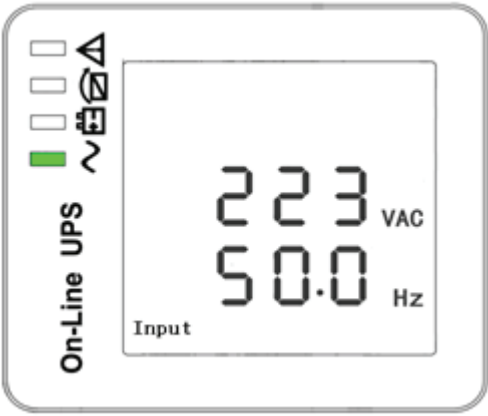
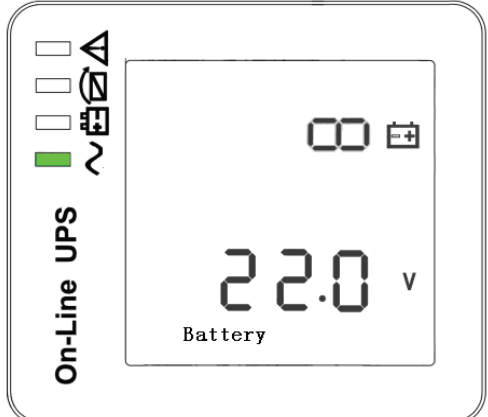
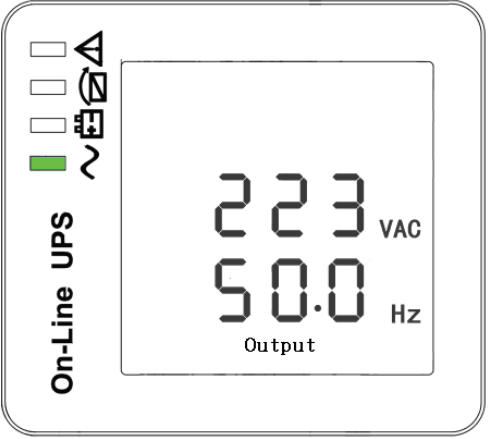
There are 9 interfaces available in the LCD display.

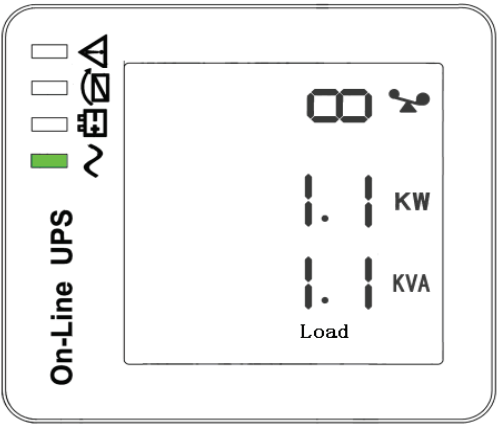
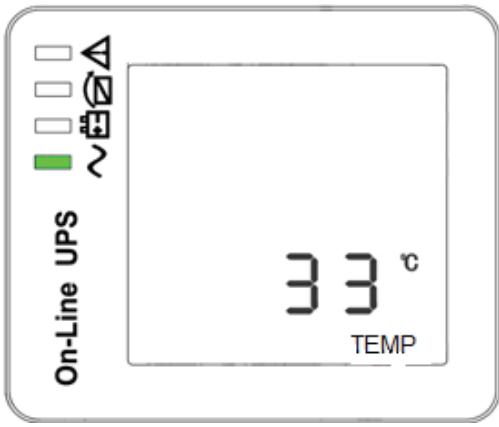

Item	Interface Description	Content Displayed
01	Input voltage	
02	Battery voltage	
03	Output voltage	

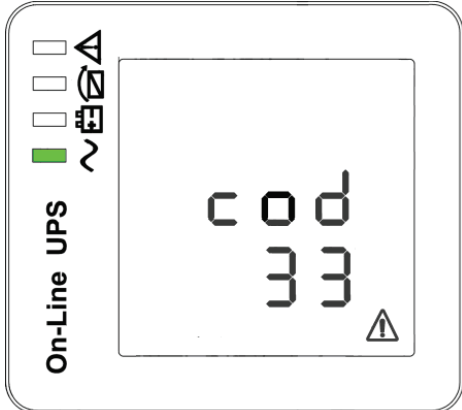

04	Load	 <p>The LCD display for 'Load' shows 'On-Line UPS' with a green bar and a sine wave icon. The main display area shows '8' with a lightning bolt icon, followed by '1.1 KW' and '1.1 KVA'. The word 'Load' is at the bottom.</p>
05	Environment Temperature	 <p>The LCD display for 'Environment Temperature' shows 'On-Line UPS' with a green bar and a sine wave icon. The main display area shows '33 °C' and 'TEMP' below it.</p>
06	Firmware Version & UPS model	 <p>The LCD display for 'Firmware Version & UPS model' shows 'On-Line UPS' with a green bar and a sine wave icon. The main display area shows '5', '3.10', and '2.0 KVA'.</p>
07	CODE (Operational status and mode)	 <p>The LCD display for 'CODE' shows 'On-Line UPS' with a green bar and a sine wave icon. The main display area shows a 7-digit code '709005'.</p>

08	<p>Alarm Code(Warming Message)</p> <p>All alarm codes are present when abnormal behavior(s) occur(s)</p>	 <p>The image shows a rectangular LCD display. At the top left, it says 'On-Line UPS' next to a green bar and a sine wave icon. The main display area shows 'c o d' on the top line and '3 3' on the bottom line. A warning triangle icon is in the bottom right corner.</p>
----	--	--

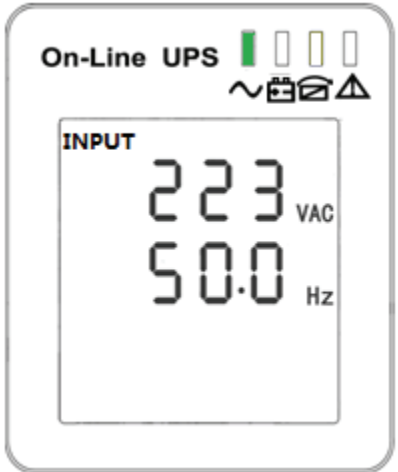
Part two: Tower display

- After the UPS turn ON, continue to press the function key for 10 seconds , the LCD screen begin to rotate.
- LCD display with rotation function and after rotating display information content is constant ,the LCD display information only display the direction and pattern of change.
- LCD display after rotation, and then shut down, to boot, the LCD screen saved with rotating state .

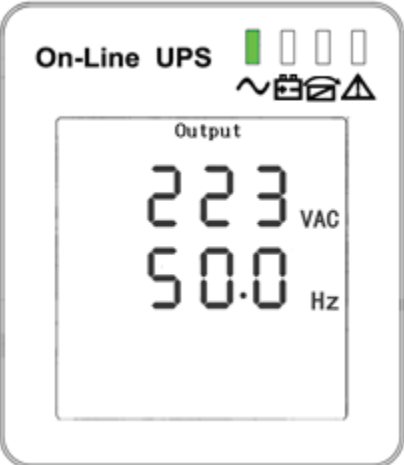
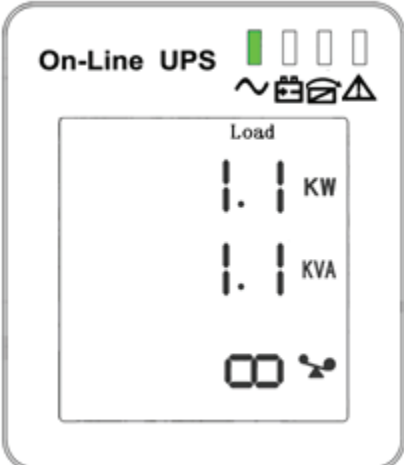
Item	Interface Description	Content Displayed
01	Input voltage	 <p>The image shows a rectangular LCD display. At the top left, it says 'On-Line UPS' next to a green bar and a sine wave icon. Below that are three vertical bars of varying heights. The main display area shows 'INPUT' at the top, '223 VAC' in the middle, and '50.0 Hz' at the bottom.</p>
02	Battery voltage	 <p>The image shows a rectangular LCD display. At the top left, it says 'On-Line UPS' next to a green bar and a sine wave icon. Below that are three vertical bars of varying heights. The main display area shows 'BATTERY' at the top, '22.0 V' in the middle, and a battery icon at the bottom.</p>

03	Output voltage	 <p>The display shows 'On-Line UPS' at the top with a green bar and four empty bars. Below are icons for AC, battery, and warning. The main display area is titled 'Output' and shows '223 VAC' and '50.0 Hz'.</p>
04	Load	 <p>The display shows 'On-Line UPS' at the top with a green bar and four empty bars. Below are icons for AC, battery, and warning. The main display area is titled 'Load' and shows '1.1 KW' and '1.1 KVA'. At the bottom, there are icons for a battery and a plug.</p>
05	Environment Temperature	 <p>The display shows 'On-Line UPS' at the top with a green bar and four empty bars. Below are icons for AC, battery, and warning. The main display area is titled 'TEMP' and shows '33 °C'.</p>
06	Firmware Version & UPS model	 <p>The display shows 'On-Line UPS' at the top with a green bar and four empty bars. Below are icons for AC, battery, and warning. The main display area shows 'S 910', '2.0 KVA', and 'UEA'.</p>

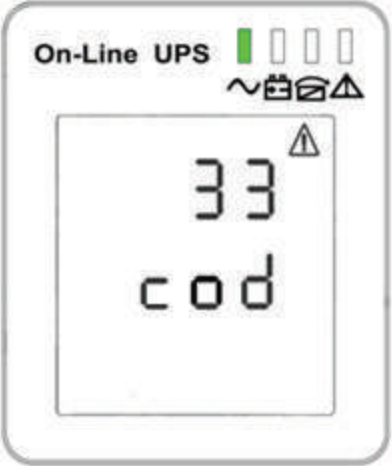
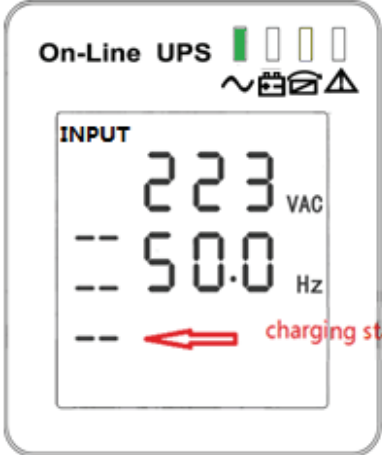
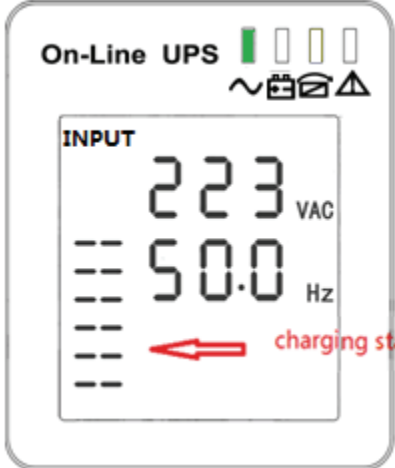
07	CODE (Operational status and mode)	 <p>The display shows 'On-Line UPS' at the top with a green bar and four empty bars. Below are icons for AC, battery, and alarm. The main display shows 'S' at the top, 'cod' in the middle, and 'NOA' at the bottom.</p>
08	Alarm Code(Warming Message) All alarm codes are present when abnormal behavior(s) occur(s)	 <p>The display shows 'On-Line UPS' at the top with a green bar and four empty bars. Below are icons for AC, battery, and alarm. The main display shows '33' at the top with a small alarm triangle icon to its right, and 'cod' below it.</p>
09	The charging status can also be shown on the screen as below while the charger is on. Cc MODE	 <p>The display shows 'On-Line UPS' at the top with a green bar and four empty bars. Below are icons for AC, battery, and alarm. The main display shows 'INPUT' at the top, '223 VAC' in the middle, and '50.0 Hz' below it. A red arrow points to the '50.0 Hz' line with the text 'charging status'.</p>
	Cv MODE	 <p>The display shows 'On-Line UPS' at the top with a green bar and four empty bars. Below are icons for AC, battery, and alarm. The main display shows 'INPUT' at the top, '223 VAC' in the middle, and '50.0 Hz' below it. A red arrow points to the '50.0 Hz' line with the text 'charging status'.</p>

3-3 UPS setting





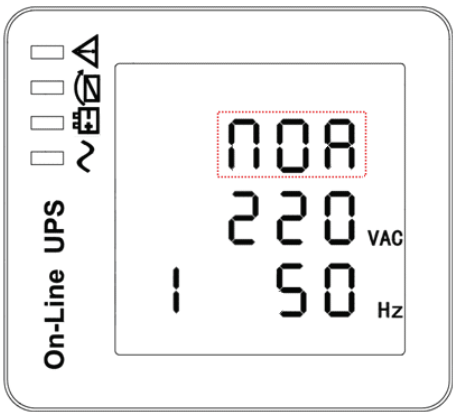
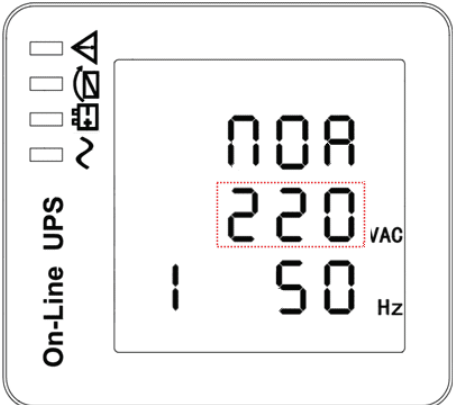
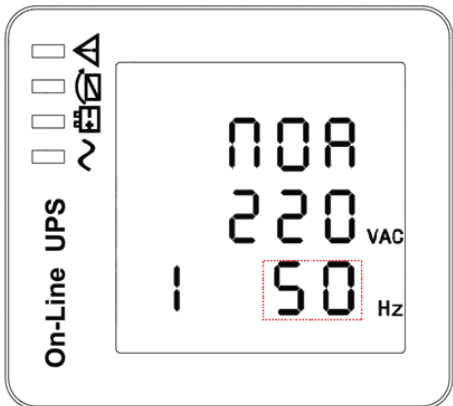

The UPS has setting functions. This user settings can be done under any kind of UPS working mode. The setting will take effect under certain condition. Below table describes how to set the UPS.

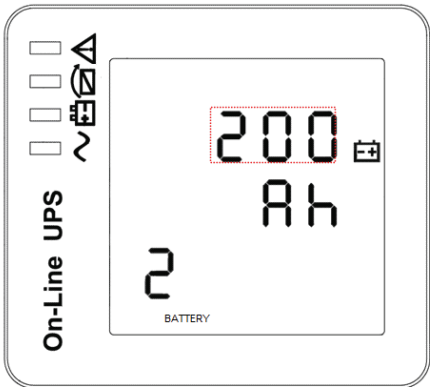
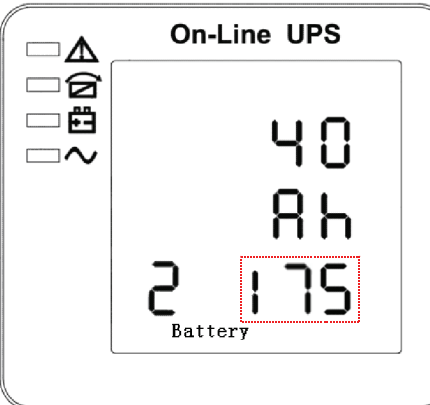
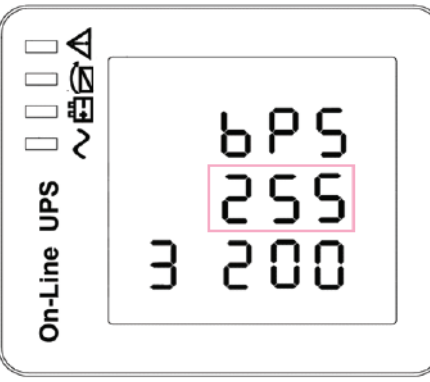
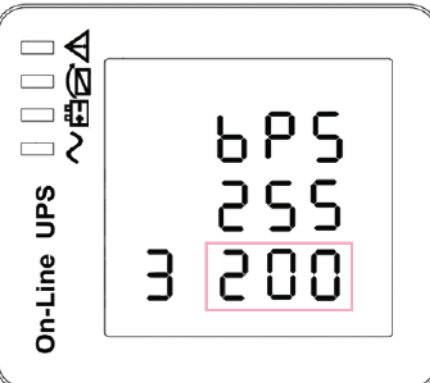
The setting function is controlled by 3 buttons (FUNC/Up▲ ,OFF/Down▼, ON/Enter⌫): FUNC/Up ▲+OFF/Down▼---goes into the setting page, ON/Enter ⌫---value adjustment; FUNC/Up ▲ & OFF/Down ▼---for choosing different pages.

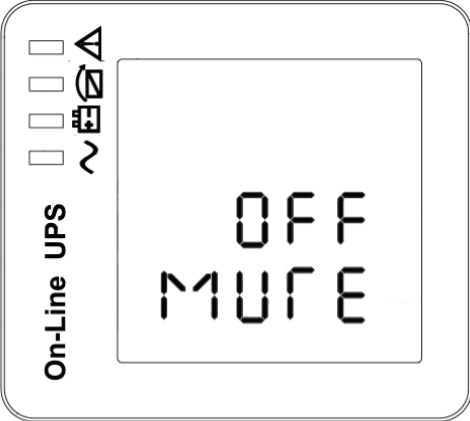

After the UPS turn ON, press buttons “▲&▼” for 5 seconds and then goes into the setting interface page.

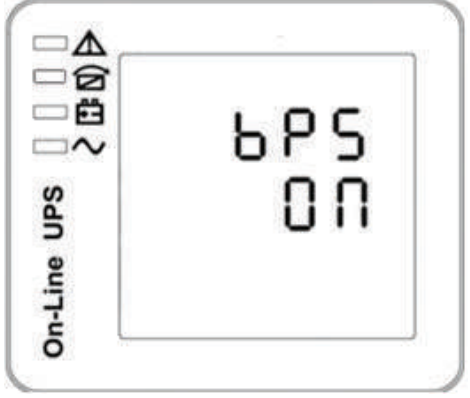

Item	Settings	Content display
01	<p style="text-align: center;">Mode setting</p> <p>Press Enter button ⌫ to change the setting (NOR or ECO or CF). Press UP button ▲ to select the previous setting. Press DOWN button ▼ to select the next setting.</p>	 <p>The display shows 'On-Line UPS' on the left. The main display area shows three lines of information: '208' (VAC) with a red dashed box around it, '220' (VAC), and '50' (Hz). There are four indicator lights at the top left of the display area.</p>
02	<p style="text-align: center;">Output voltage setting</p> <p>Press Enter button ⌫ to change the setting(200,208 , 220, 230, 240). Press UP button ▲ to select the previous setting. Press DOWN button ▼ to select the next setting.</p>	 <p>The display shows 'On-Line UPS' on the left. The main display area shows three lines of information: '208' (VAC), '220' (VAC) with a red dashed box around it, and '50' (Hz). There are four indicator lights at the top left of the display area.</p>
03	<p style="text-align: center;">Frequency setting</p> <p>Press Enter button ⌫ to change the setting (50 or 60Hz). Press UP button ▲ to select the previous setting. Press DOWN button ▼ to select the next setting.</p>	 <p>The display shows 'On-Line UPS' on the left. The main display area shows three lines of information: '208' (VAC), '220' (VAC), and '50' (Hz) with a red dashed box around it. There are four indicator lights at the top left of the display area.</p>

04	<p align="center">Battery capacity setting</p> <p>Press Enter button \cup to change the setting (Battery capacity range is 1-200Ah). Press UP button \blacktriangle to select the previous setting. Press DOWN button \blacktriangledown to select the next setting.</p>	 <p>The LCD display shows 'On-Line UPS' on the left with four status icons. The main display area shows '200' in the top line, 'Ah' in the middle line, and 'BATTERY' in the bottom line. A red dashed box highlights the '200' value.</p>
05	<p>EOD voltage setting</p> <p>Press Func button to change the setting(160/167/175/180.) default setting: 175(1.75V /cell) Press UP button \blacktriangle to select the previous setting. Press DOWN \blacktriangledown button to select the next setting.</p>	 <p>The LCD display shows 'On-Line UPS' at the top. On the left, there are four status icons and a sine wave symbol. The main display area shows '40' in the top line, 'Ah' in the middle line, and '175' in the bottom line. 'Battery' is written below the bottom line. A red dashed box highlights the '175' value.</p>
06	<p>Bypass voltage upper limit setting</p> <p>Press Enter button \cup to change the setting(The bypass voltage upper limit range is 230-264Vac). Press UP button \blacktriangle to select the previous setting. Press DOWN button \blacktriangledown to select the next setting.</p>	 <p>The LCD display shows 'On-Line UPS' on the left with four status icons. The main display area shows '095' in the top line, '255' in the middle line, and '200' in the bottom line. A red dashed box highlights the '255' value.</p>
07	<p>Bypass voltage lower limit setting</p> <p>Press Enter button \cup to change the setting(The bypass voltage lower limit range is 170-220Vac). Press UP button \blacktriangle to select the previous setting. Press DOWN button \blacktriangledown to select the next setting.</p>	 <p>The LCD display shows 'On-Line UPS' on the left with four status icons. The main display area shows '095' in the top line, '255' in the middle line, and '200' in the bottom line. A red dashed box highlights the '200' value.</p>

08	<p style="text-align: center;">Mute setting</p> <p>Press Enter button  to change the setting(ON or OFF). Press UP button  to select the previous setting. Press DOWN button  to save and exit the setup.</p>	
09	<p style="text-align: center;">BYPASS enable/disable setting</p> <p>Press Enter button  to change the setting(ON or OFF). Press UP button  to select the previous setting. Press DOWN button  to save and exit the setup.</p>	

3-4 Operating Mode Description

Mode	Description	Indicator
Line Mode	<p>The green LED is on.</p> <p>When input AC mains is in line with the working conditions, UPS will work in line mode,charge the battery and protect the load.</p>	
Battery Mode	<p>The battery yellow LED is on,and the buzzer beeps once per 4 seconds.</p> <p>When the mains power down or instable, UPS will turn to Battery Mode at once. If the mains recovers,the UPS will transfer to line mode.</p> <p>If battery voltage low alarm activates, the indicator of battery LED flashes. If battery voltage reaches low limit, UPS will turn off to protect the battery. UPS will auto-restart when the mains recover.</p> <p>⚠NOTE : The back up time of Battery Mode is subject to the load and EBP numbers.</p>	

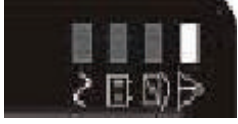
Bypass Mode	<p>The bypass yellow LED is on.</p> <p>Bypass tolerance can be set by Bypass voltage limit setting.</p> <p>Under below conditions, the UPS will transfer to bypass mode:</p> <ul style="list-style-type: none"> • BPS on set by user through Mode setting , and set to ECO Mode. • Press the OFF button when on Line Mode . • Overload on Line Mode. <p>⚠NOTE : When in bypass mode , the load is not protected.</p>	
ECO Mode	<p>The bypass yellow LED is on.</p> <p>When ECO enabled and the utility is in range, the UPS will work on ECO Mode. If the utility in out of ECO range but still in Line range, the UPS will transfer to Line Mode.</p> <p>Utility tolerance of ECO Mode can be set.</p>	
Fault Mode	<p>When the UPS has fault. The warning red LED is on and the buzzer beeps.</p> <p>The UPS will turn to fault mode. If you turn on the UPS without the Fan and the LCD display fault codes. At the moment, you can press the OFF key to shut down the UPS when the mains power down. Confirm that there is no serious fault to turn on the UPS.</p> <p>⚠NOTE: As for corresponding information of the fault code, please refer to alarm or fault reference code.</p>	

3-5 Operational Status and Mode(s)

item	Content Displayed
2	Standby Mode
3	No Output
4	Bypass Mode
5	Utility Mode
6	Battery Mode
7	Battery Self-diagnostics
8	Inverter is starting up

9	ECO Mode
10	EPO Mode
11	Maintenance Bypass Mode
12	Fault Mode

3-6 Alarm or Fault reference code

Event log	UPS Alarm Warning	Buzzer	LED
2	Inverter fault(Including Inverter bridge is shorted)	Beep continuously	Fault LED lit
9	Fan fault	Beep continuously	Fault LED lit
12	Selftest fault	Beep continuously	Fault LED lit
13	Battery Charger fault	Beep continuously	Fault LED lit
15	DC Bus over voltage	Beep continuously	Fault LED lit
16	DC Bus below voltage	Beep continuously	Fault LED lit
17	DC bus unbalance	Beep continuously	Fault LED lit
18	Soft start failed	Beep continuously	Fault LED lit
19	UPS Inside Over Temperature	Twice per second	Fault LED lit
20	Heatsink Over Temperature	Twice per second	Fault LED lit
26	Battery over voltage	Once per second	Fault LED blinking
29	Output Short-circuit	Once per second	Fault LED blinking
30	Input current limit	Once per second	Fault LED blinking
31	Bypass over current	Once per second	BPS LED blinking
32	Overload	Once per second	INV or BPS LED blinking
33	No battery	Once per second	Battery LED blinking
34	Battery under voltage	Once per second	Battery LED blinking
35	Battery low pre-warning	Once per second	Battery LED blinking
36	Over load time out	Once per 2 seconds	Fault LED blinking
37	DC component over limit.	Once per 2 seconds	INV LED blinking
39	Mains volt. Abnormal	Once per 2 seconds	Battery LED lit
40	Mains freq. abnormal	Once per 2 seconds	Battery LED lit
41	Bypass Not Available		BPS LED blinking

4. Troubleshooting

If the UPS system does not operate correctly, please solve the problem by using the table below and the Trouble Shooting Chart.

Symptom	Possible cause	Remedy
No indication and alarm even though the mains is normal.	The AC input power is not connected well.	Check if input power cord firmly connected to the mains.
	The AC input is connected to the UPS output.	Plug AC input power cord to AC input correctly.
Alarm code is shown as "33" and battery led blinking.	The external or internal battery is incorrectly connected.	Check if all batteries are connected well.
Alarm code is shown as "26" and battery led blinking.	Battery voltage is too high or the charger is fault.	Contact your dealer.
Alarm code is shown as "34" and battery led blinking	Battery voltage is too low or the charger is fault.	Contact your dealer.
Alarm code is shown as "32" and INV or BYPASS led blinking.	UPS is overload	Remove excess loads from UPS output.
Alarm code is shown as "29" and FAULT led light.	The UPS shut down automatically because short circuit occurs on the UPS output.	Check output wiring and if connected devices are in short circuit status.
Alarm code is shown as "9" and FAULT led light.	Fan fault.	Contact your dealer.
Alarm code is shown as "01,02, 15,16,17,18"	A UPS internal fault has occurred.	Contact your dealer.
Battery backup time is shorter than nominal value	Batteries are not fully charged	Charge the batteries for at least 5 hours and then check capacity. If the problem still persists, consult your dealer.
	Batteries defect	Contact your dealer to replace the battery.

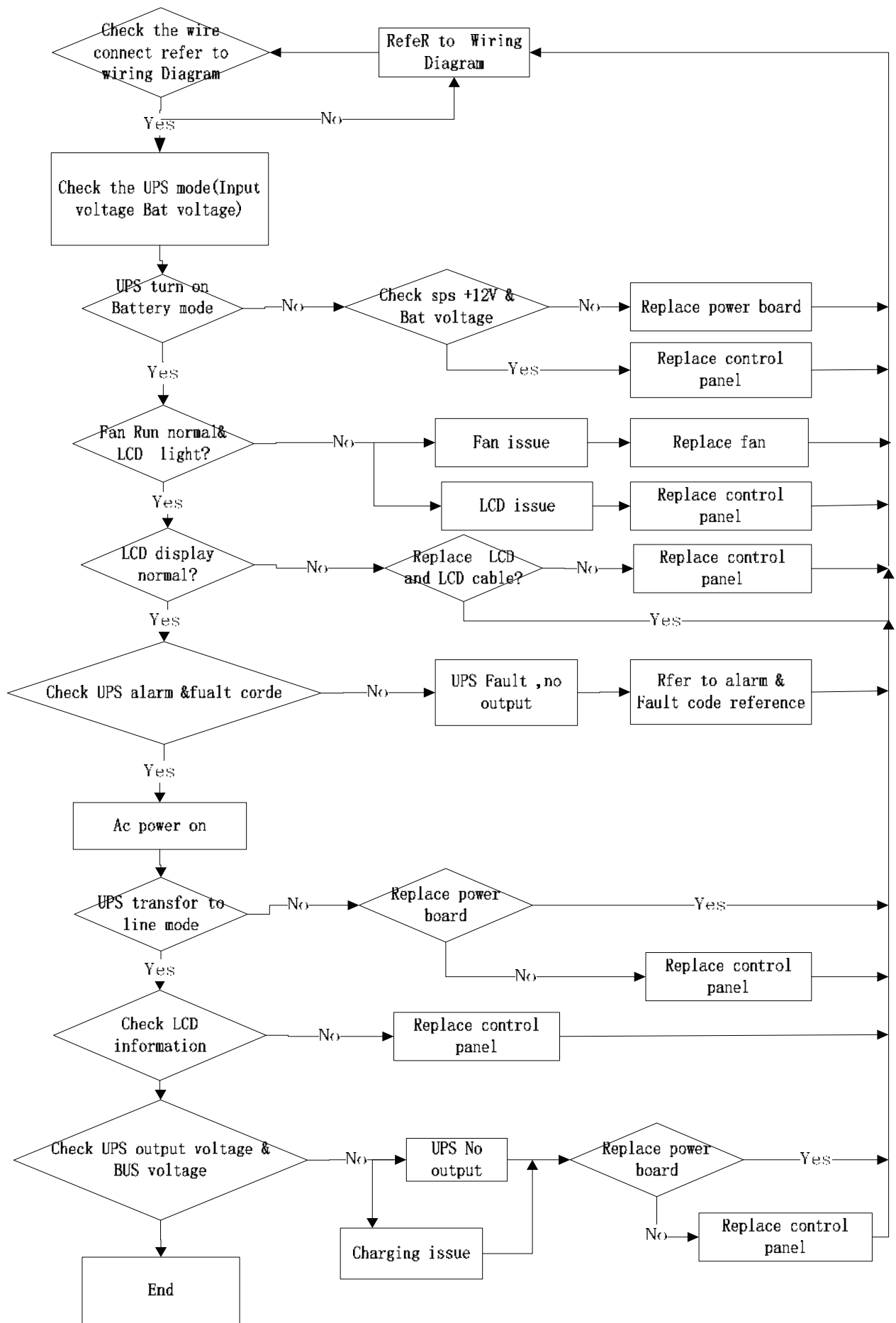

Trouble Shooting Chart

5. Storage and Maintenance

● Operation

The UPS system contains no user-serviceable parts. If the battery service life (3~5 years at 25°C ambient temperature) has been exceeded, the batteries must be replaced. In this case, please contact your dealer.



Be sure to deliver the spent battery to a recycling facility or ship it to your dealer in the replacement battery packing material.

● Storage

Before storing, charge the UPS 5 hours. Store the UPS covered and upright in a cool, dry location. During storage, recharge the battery in accordance with the following table:

Storage Temperature	Recharge Frequency	Charging Duration
-25°C - 40°C	Every 3 months	1-2 hours
40°C - 45°C	Every 2 months	1-2 hours

6. Options

SNMP card: internal SNMP

- ◆ Loosen the 2 torquescrews (on each side of the card).
- ◆ Carefully insert the SNMP card and lock the screws

The slot called SNMP supports the MEGAtec protocol. We advise that Net Agent II-3 port is also a tool to remotely monitor and manage any UPS system

NetAgent II-3 Ports supports the Modem Dial-in (PPP) function to enable the remote control via the internet when the network is unavailable.

In addition to the features of a standard NetAgent Mini, NetAgent II has the option to add Net Feeler Lite to detect temperature, humidity, smoke and security sensors. Thus, making NetAgent II a versatile management tool. NetAgent II also supports multiple languages and is set up for web-based auto language detection.

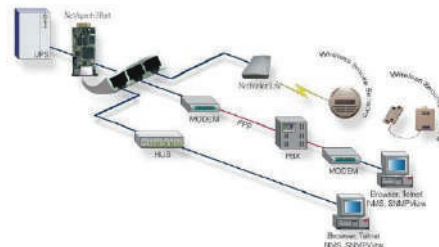

Typical topology of the UPS Network Management

Relay card

Mini dry contact card is used for providing the interface for UPS peripheral monitoring. The contact signals can reflect UPS running status. The card is connected to peripheral monitoring devices via terminal board to facilitate the

effective monitoring of the real-time status of UPS and timely feedback the status to monitor when abnormal situation occurs (such as UPS failure, mains interruption, UPS bypass and etc.). It is installed in the intelligent slot of the UPS. The relay card includes 6 output ports and one input port. Please refer to the following table for detail.



Product appearance

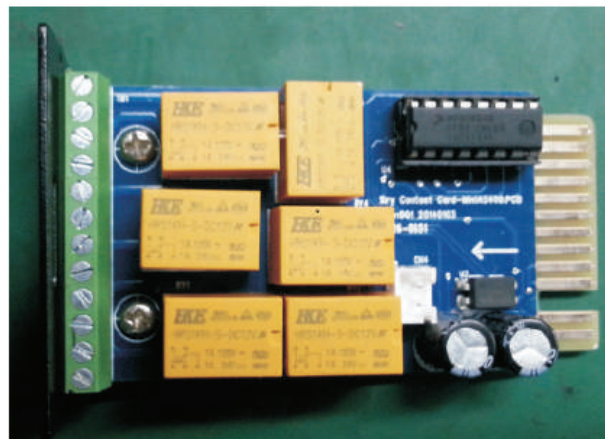

Pins definition of connecting terminal on the board

Terminal No.	Terminal function	Terminal No.	Terminal function
1	Common source	9	Bypass alive NO
2	UPS on NO	10	Bypass alive NC
3	AC fail NO	11	UPS fail NO
4	AC fail NC	12	UPS fail NC
5	Batt low NO	CN4-1	Remote shutdown
6	Batt low NC	CN4-2	GND
7	UPS alarm NO		
8	UPS alarm NC		

Relaycard electrical parameter

	max	Type
Relaycardcontact	(Max Switched Voltage) AC:120V DC:24V	AC:120V
		DC:5~12V
	(Max Switched Current) AC:1A DC:1A	AC:1A
		DC:1A

7. Specification

MODEL		1KVA(S)	1KVA(H)	2KVA(S)	2KVA(H)	3KVA(S)	3KVA(H)
PHASE		Single phase with ground					
Capacity (VA/Watts)		1000VA / 900W		2000VA / 1800W		3000VA / 2700W	
INPUT							
Nominal voltage		200/208/220/230/240VAC					
Operating voltage range	Low line transfer	160Vac±5% @100%-80% load; 140Vac±5% @80%-70% load; 120Vac±5% @70%-60% load; 110Vac±5% @60%-0% load; (Ambient Temp. <35°C)					
	Low line comeback	175Vac±5% @100%-80% load; 155Vac±5% @80%-70% load; 135Vac±5% @70%-60% load; 125Vac±5% @60%-0% load; (Ambient Temp. <35°C)					
	High line transfer	300Vac ±5%					
	High line comeback	290Vac ±5%					
Operating frequency range		40-70Hz					
Power factor		0.99@100% load(Nominal Input Voltage)					
Bypass voltage range		<p align="center">Bypass high voltage point 230-264: setting the high voltage point in LCD from 230Vac to 264Vac. (Default: 264Vac) Bypass low voltage point 170-220: setting the low voltage point in LCD from 170Vac to 220Vac. (Default: 170Vac)</p>					
Generator input		Support					
OUTPUT							
Output voltage		200/208/220/230/240Vac					
Power factor		0.9					
Voltage regulation		±1%					
Frequency	Line Mode (synchronized range)	47-53Hz or 57-63Hz					
	Bat. Mode	(50/60±0.1)Hz					
Crest factor		3:1					
Harmonic distortion (THDv)		≤2% THDwith linear load ≤4% THD with non linear load					
Waveform		Pure Sinewave					
Transfer time	AC mode <-> Batt. mode	Zero					
	Inverter <-> bypass	4ms(Typical)					
Efficiency		88%(AC mode) 85%(DC mode)		92%(AC mode) 88%(DC mode)		92%(AC mode) 90%(DC mode)	
BATTERY							

Battery Type	12V9AH	depends on the capacity of external batteries		12V9AH	depends on the capacity of external batteries		12V9AH	depends on the capacity of external batteries	
Numbers	2	2	3	4	4	6	6	6	8
Backup time	Long run unit depends on the capacity of external batteries								
Typical recharge time(standard modle)	4 hours recover to 90% capacity (Typical)								
Charging voltage	27.4 VDC ±1%	27.4 VDC ±1%	41.0 VDC ±1%	54.7 VDC ±1%	54.7 VDC ±1%	82.1 VDC ±1%	82.1 VDC ±1%	82.1 VDC ±1%	109.4 VDC ±1%
Charge current	1A or 2A	12A max, can be setting by LCD		1A or 2A	12A max, can be setting by LCD		1A or 2A	12A max, can be setting by LCD	
SYSTEM FEATURES									
Overload @35°C	Line Mode Battery Mode	<p style="text-align: center;">Ambient Temp.<35°C</p> <p>105%~110%: UPS transfer to bypass after 10minuteswhen the utility is normal 110%~130%: UPS transfer to bypass after 1minute when the utility is normal 130%~150%: UPS transfer to bypass after 5 seconds when the utility is normal >150%: UPS transfer to bypass immediately when the utility is normal</p> <p style="text-align: center;">35°C<Ambient Temp.<40°C</p> <p>105%~110%: UPS transfer to bypass after 1minute when the utility is normal 110%~130%: UPS transfer to bypass after 5 seconds when the utility is normal >130%: UPS transfer to bypass immediately when the utility is normal</p>							
		<p style="text-align: center;">Hold Whole System</p>							
Short Circuit	Hold Whole System								
Overheat	Line Mode: Switch to Bypass; Backup Mode: Shut down UPS immediately								
Low battery voltage	Alarm and Switch off								
EPO (optional)	Shut down UPS immediately								
Audible & Visual alarms	Line Failure, Battery Low, Overload, System Fault								
Comunication interface	USB(or RS232), SNMPcard(optional), Relay card (optional)								
ENVIRONMENTAL									
Operating temperature	0°C~40°C								
Storage temperature	-25°C~55°C								
Humidity range	20-90 % RH @ 0- 40°C (non-condensing)								
Altitude	< 1500m								
Noise level	Less than 50dBA at 1 Meter								
PHYSICAL									
Dimension W×D×H (mm)	440*305* 86.5			440*460*86.5	440*435*86.5		440*600* 86.5	440*435*86.5	
Net Weight (kg)	11.3	5.6	5.6	19.1	8.3	8.3	26.2	8.6	8.6
STANDARDS									
Safety	IEC/EN62040-1,IEC/EN60950-1								
EMC	IEC/EN62040-2,IEC61000-4-2,IEC61000-4-3,IEC61000-4-4, IEC61000-4-5,IEC61000-4-6,IEC61000-4-8								

* Derate to 80% of capacity when the output voltage is adjusted to 200/208VAC

** Product specifications are subject to change without further notice.