

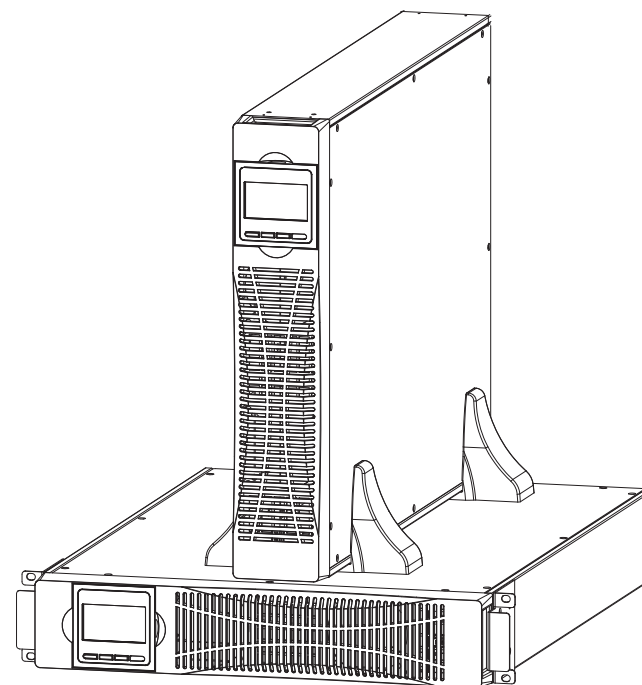

Manual Usuario

UPS ESOL RTH-C

6-10 kVA



All rights reserved.

The information in this document is subject to change without notice.

Publish statement

Thank you for purchasing this series UPS.

This series UPS is an intelligent, single phase in single phase out, high frequency online UPS designed by our R&D team who is with years of designing experiences on UPS. With excellent electrical performance, perfect intelligent monitoring and network functions, smart appearance, complying with EMC and safety standards, This UPS has become standard product which meets the world's advanced level.

Read this manual carefully before installation

This manual offers technical support for equipment operator

Contents

1. Safety	- 2 -
1.1 Safety notes	- 2 -
1.2 Symbols used in this guide	- 2 -
2. Main Features	- 3 -
2.1 Summarization	- 3 -
2.2 Functions and Features	- 3 -
3. Installation	- 4 -
3.1 Unpack checking	- 4 -
3.2 UPS Module Outlook	- 4 -
3.3 LCD control panel	- 5 -
3.4 Installation notes	- 6 -
3.5 External Protective Devices	- 6 -
3.6 Power Cables	- 7 -
3.7 Power cable connect	- 8 -
3.8 Battery connection	- 8 -
3.9 UPS Multi—Module Installation	- 9 -
3.9.1 Cabinet installation	- 10 -
3.9.2 Parallel cable installation	- 10 -
3.9.3 Requirement for the parallel system	- 11 -
4. Operation	- 12 -
4.1 Operation Modes	- 12 -
4.2 Turn on/off UPS	- 12 -
4.2.1 Connecting with Utility	- 12 -
4.2.2 Black(Cold) start procedure	- 13 -
4.2.3 Inverter Off	- 13 -
4.2.4 Disconnecting with Utility	- 14 -
4.3 LCD Display instruction	- 14 -
4.4 Parameters setting	- 16 -
4.4.1 Mode setting	- 16 -
4.4.2 Output voltage setting	- 16 -
4.4.3 Output frequency setting	- 17 -
4.4.4 Battery capacity setting	- 17 -
4.4.5 Battery quantity setting	- 18 -
4.4.6 Bypass Volt-Hi setting	- 18 -
4.4.7 Bypass Volt-Lo setting	- 19 -
4.4.8 Buzzer Mute Setting	- 19 -
4.4.9 Battery Test Setting	- 20 -
4.4.10 Parallel ID setting	- 21 -
4.4.11 Parallel quantity setting	- 21 -
4.4.12 Parallel redundancy quantity setting	- 22 -
Appendix 1 Specifications	- 23 -
Appendix 2 Communication port definition	- 25 -
Appendix 3 Option	- 25 -
Appendix 4 UPS message table	- 26 -

1. Safety

Important safety instructions – Save these instructions

There exists dangerous voltage and high temperature inside the UPS. During the installation, operation and maintenance, please abide the local safety instructions and relative laws, otherwise it will result in personnel injury or equipment damage. Safety instructions in this manual act as a supplementary for the local safety instructions. Our company will not assume the liability that caused by disobeying local safety instructions.

1.1 Safety notes

1. Even no connection with utility power, 208/220/230/240VAC voltage may still exist at UPS outlet!
2. For the sake of human being safety, please well earth the UPS before starting it .
3. Don't open or damage battery, for the liquid spilled from the battery is strongly poisonous and do harmful to body!
4. Please avoid short circuit between anode and cathode of battery, otherwise, it will cause spark or fire!
5. Don't disassemble the UPS cover, or there may be an electric shock!
6. Check if there exists high voltage before touching the battery
7. Working environment and storage way will affect the lifetime and reliability of the UPS. Avoid the UPS from working under following environment for long time
 - ◆ Area where the humidity and temperature is out of the specified range(temperature 0 to 40°C, relative humidity 5%-95%)
 - ◆ Direct sunlight or location nearby heat
 - ◆ Vibration Area with possibility to get the UPS crashed.
 - ◆ Area with erosive gas, flammable gas, excessive dust, etc
8. Keep ventilations in good conditions otherwise the components inside the UPS will be over-heated which may affect the life of the UPS.

1.2 Symbols used in this guide



WARNING!

Risk of electric shock



CAUTION!

Read this information to avoid equipment damage

2. Main Features

2.1 Summarization

This series UPS is a kind of single phase in single phase out high frequency online UPS, it provides two capacities: The 6kVA and 10kVA. The products are modularized and adopt the N+X redundancy. It can flexibly increase the number of the UPS modules according to the load capacity which is convenient for flexible allocation and gradually investment.

The UPS can solve most of the power supply problems, such as blackout, over-voltage, under-voltage, voltage sudden drop, oscillating of decreasing extent, high voltage pulse, voltage fluctuation, surge, inrush current, harmonic distortion (THD), noise interference, frequency fluctuation, etc..

This UPS can be applied to different applications from computer device, automatic equipment, communication system to industry equipment.

2.2 Functions and Features

◆1Phase In/1Phase Out UPS

It is 1Phase In/1Phase Out high-density UPS system, of which input current is kept in balance. No unbalance problem might occur. And also support for single phase input.

◆Digital Control

This series UPS is controlled by Digital Signal Processor(DSP); enhance, it increases reliability, performance, self-protector, self-diagnostics and so on.

◆Battery Configurable from 16pcs to 20pcs

The battery voltage of this series UPS can be configured at 16pcs, 18pcs or 20pcs according to your convenience.

◆Intelligent Charging Method

The series UPS adopts advanced three-stage charging method—

1st stage: high current constant current charging
to guarantee to charge back to 90%;

2nd-stage: Constant Voltage

In order to vitalize battery and make sure batteries are fully charged

3rd stage: floating mode.

With this 3-stage charging method, it extends the life of the batteries and guarantees fast charging.

◆LCD Display

With LCD plus LED displays, the user may easily get UPS status and its operational parameters, such as input/output voltage, frequency & load%, battery % and ambient temperature, etc..

◆Intelligent Monitoring Function

Via optional SNMP Card, you may remotely control and monitor the UPS.

3. Installation

3.1 Unpack checking

1. Don't lean the UPS when moving it out from the packaging
2. Check the appearance to see if the UPS is damaged or not during the transportation, do not switch on the UPS if any damage found. Please contact the dealer right away.
3. Check the accessories according to the packing list and contact the dealer in case of missing parts.

3.2 UPS Module Outlook

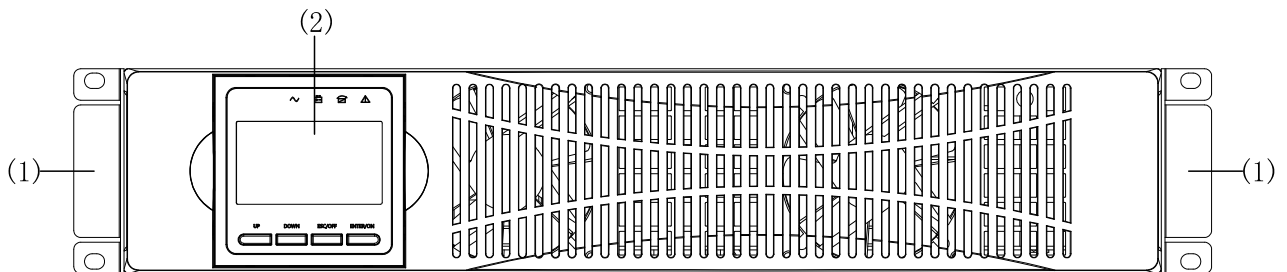

Front View

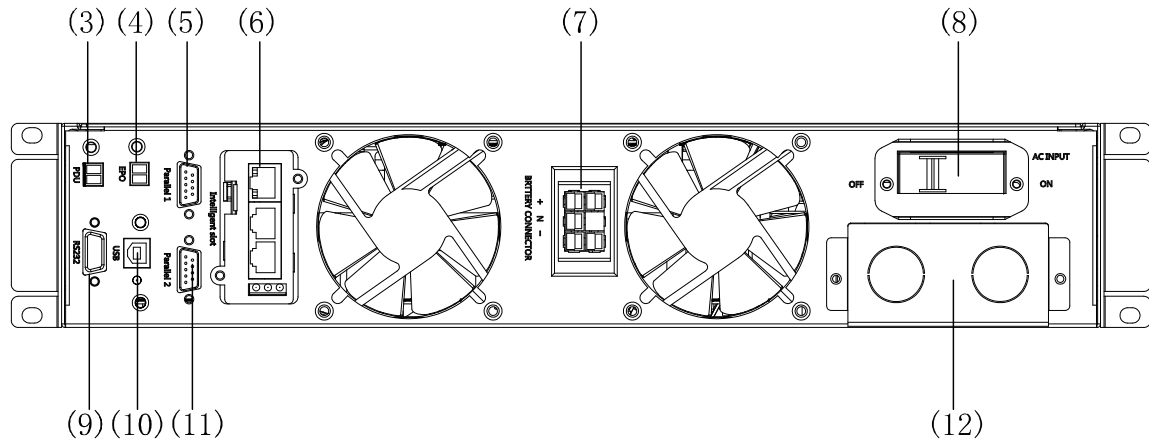

Rear View

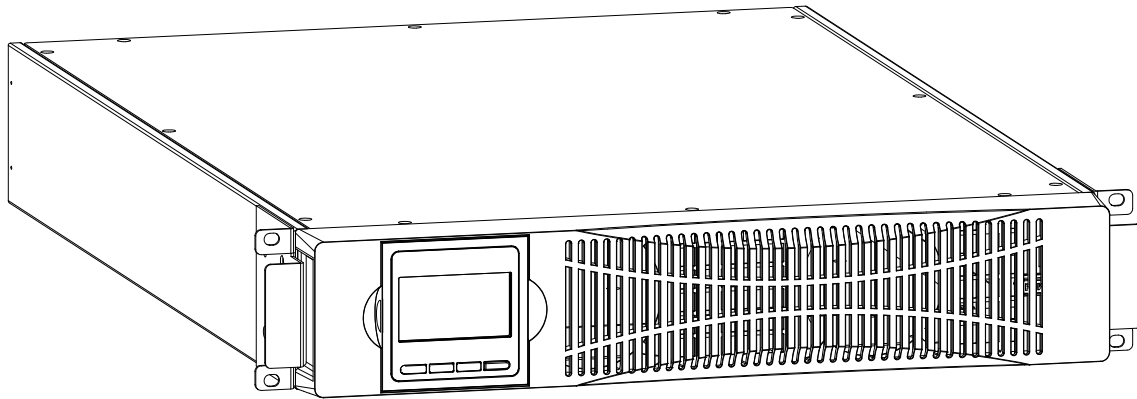

Side View

- (1) handles (2) LCD Display (3) PDU (4) EPO (5) Parallel Port 1
 (6) Intelligent slot (7) Battery Slot (8) Input breaker (9) COM (RS232) (10) USB
 (11) Parallel Port 2 (12)terminal

3.3 LCD control panel

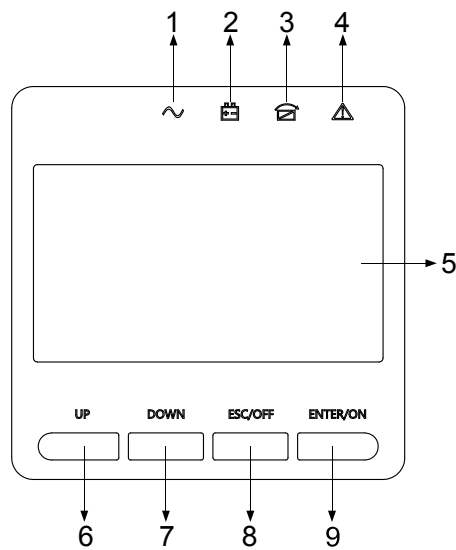

LCD control panel introduction

- (1) INVERTER LED
- (2) BATTERY LED
- (3) BYPASS LED
- (4) ALARM LED
- (5) LCD display
- (6) UP button
- (7) DOWN button
- (8) ESC /OFF button
- (9) ENTER/ON button

3.4 Installation notes

◆ Please place the UPS in a clean, stable environment, avoid the vibration, dust, humidity, flammable gas and liquid, corrosive objects. To avoid from high room temperature, a system of room extractor fans is recommended to be installed. Optional air filters are available if the UPS operates in a dusty environment.

◆ The environment temperature around the UPS should keep in a range of 0°C~40°C. If the environment temperature exceeds 40°C, the rated load capacity should be reduced by 12% per 5°C. The max temperature can't be higher than 50°C.

◆ If the UPS is dismantled under low temperature, it might be in a condensing condition. The UPS can't be installed unless the internal and external of the equipment is fully dry. Otherwise, there will be in danger of electric shock.

◆ Batteries should be mounted in an environment where the temperature is within the required specs. Temperature is a major factor in determining battery life and capacity. In a normal installation, the battery temperature is maintained between 15°C and 25°C. Keep batteries away from heat sources or main air ventilation area, etc.



WARNING!

Typical battery performance data are quoted for an operating temperature between 20°C and 25°C. Operating it above this range will reduce the battery life while operation below this range will reduce the battery capacity.

◆ Should the equipment not be installed immediately it must be stored in a room so as to protect it against excessive humidity and or heat sources.



CAUTION!

An unused battery must be recharged every 3 months. Temporarily connecting the UPS to a suitable AC supply and activating it for the time required for recharging the batteries are required.

◆ The highest altitude that UPS may work normally with full load is 1500 meters. The load capacity should be reduced when this UPS is installed in place whose altitude is higher than 1500 meters, shown as the following table:

(Load coefficient equals max load in high altitude place divided by nominal power of the UPS)

Altitude (m)	1500	2000	2500	3000	3500	4000	4500	5000
Load coefficient	100%	95%	90%	85%	80%	75%	70%	65%

◆ To get the UPS completely monitored by the software, you just simply connect RS232 or USB cable to each end of the computer and the UPS respectively.

3.5 External Protective Devices

For safety reasons, it is necessary to install, external circuit breaker at the input A.C. supply and the battery. This chapter provides guidelines for qualified installers that must have the knowledge of local wiring practices for the equipment to be installed.

◆ External Battery

The UPS and its associated batteries are protected against the effect of over-current through a DC compatible thermo-magnetic circuit-breaker (or a set of fuses) located close to the battery.

◆UPS Output

Any external distribution board used for load distribution shall be fitted with protective devices that may avoid the risk of UPS overloaded.

◆Over-current

Protection device shall be installed at the distribution panel of the incoming main supply. It may identify the power cables current capacity as well as the overload capacity of the system .



CAUTION !

Select a thermo magnetic circuit-breaker with an IEC 60947-2 trip curve C (normal) for 125% of the current as listed below.

3.6 Power Cables

◆The cable design shall comply with the voltages and currents provided in this section, Kindly follow local wiring practices and take into consideration the environmental conditions (temperature and physical support media) .

WARNING!



UPON STARTING, PLEASE ENSURE THAT YOU ARE AWARE OF THE LOCATION AND OPERATION OF THE EXTERNAL ISOLATORS WHICH ARE CONNECTED TO THE UPS INPUT/BYPASS SUPPLY OF THE MAINS DISTRIBUTION PANEL.CHECK TO SEE IF THESE SUPPLIES ARE ELECTRICALLY ISOLATED, AND POST ANY NECESSARY WARNING SIGNS TO PREVENT ANY INADVERTENT OPERATION.

Cable Dimension

UPS module	Cable Dimension			
	AC Input (mm ²)	AC Output (mm ²)	DC Input (mm ²)	Grounding (mm ²)
6KVA	6	6	6	6
10KVA	10	10	10	10



CAUTION!

Protective earth cable: Connect each cabinet to the main ground system. For Grounding connection, follow the shortest route possible.



WARNING!

FAILURE TO FOLLOW ADEQUATE EARTHING PROCEDURES MAY RESULT IN ELECTROMAGNETIC INTERFERENCE OR IN HAZARDS INVOLVING ELECTRIC SHOCK AND FIRE.

3.7 Power cable connect

Once the equipment has been finally positioned and secured, connect the power cables as described in the following procedure.

Verify the UPS is totally isolated from its external power source and also all power isolators of the UPS are open. Check to see if they are electrically isolated, and post any necessary warning signs to prevent their inadvertent operation .

Choose appropriate power cable, and pay attention to the diameter of the connection terminal of the cable that should be greater than or equal to that of the connection poles;

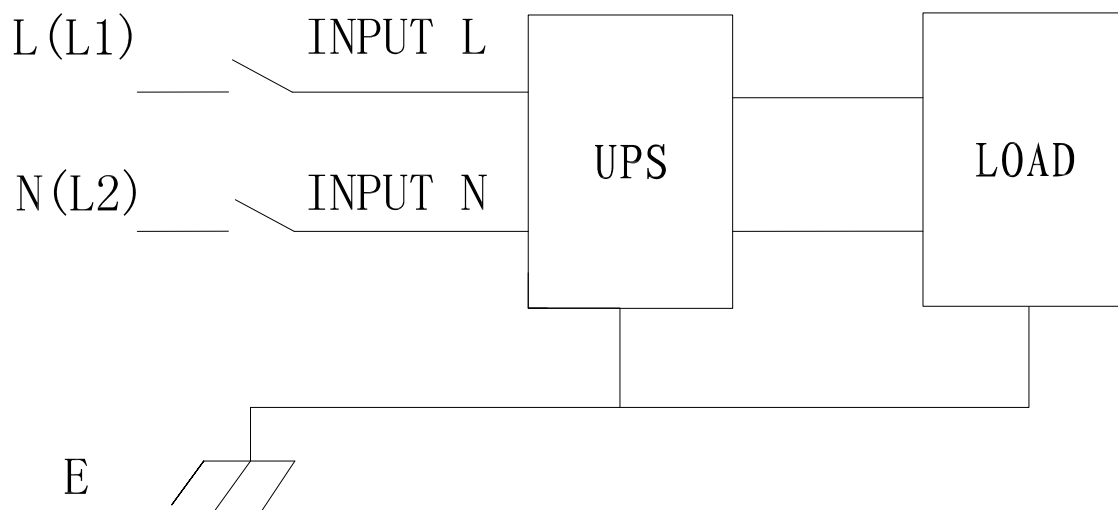

Input connection “single phase + ground”



WARNING!

If the load equipment is not ready to accept power on the arrival of the commissioning engineer then ensure that the system output cables are safely isolated at their ends



CAUTION!

The earthing and neutral bonding arrangement must be in accordance with local and national codes of practice.

3.8 Battery connection

The UPS uses a positive and negative double battery framework, total 16(optional 18/20) pieces in series. A neutral cable is retrieved from the joint between the cathode of the 8th (9th/10th) and the anode of the 9th (10th /11th) of the batteries. Then the neutral, the battery positive and the battery negative are connected with the UPS respectively. The battery sets between the Battery anode and the neutral are called positive batteries and that between neutral and cathode are called negative ones. Users can choose the capacity and the numbers of the batteries according to their demands. The connection is shown as following:

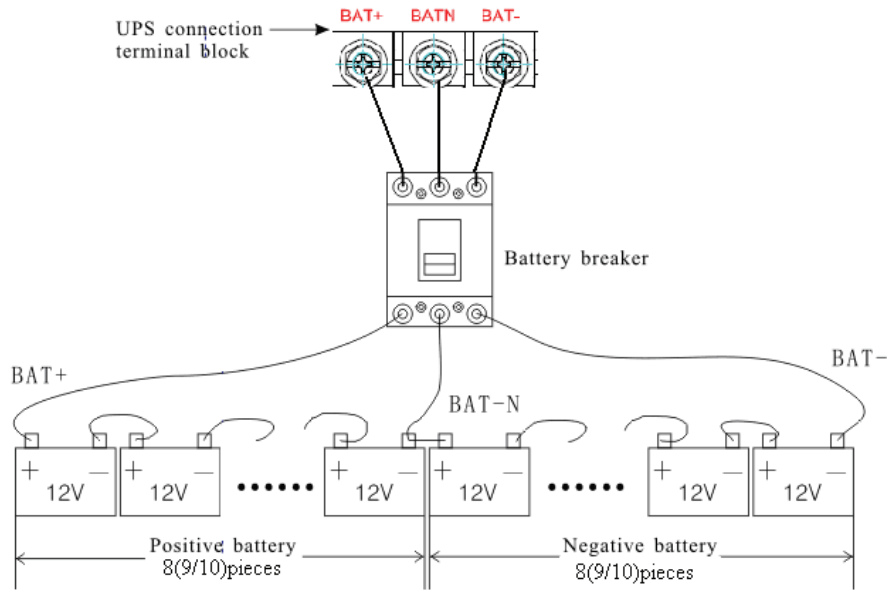

Note:

The BAT+ of the UPS connect poles is connected to the anode of the positive battery, the BAT- is connected to the cathode of the positive battery and the anode of the negative battery, the BAT- is connected to the cathode of the negative battery.

Factory default setting for battery quantity is 16pcs and for battery capacity is 7AH (charger current 1A). When connecting 18pcs or 20pcs batteries, please re-set battery quantity and its capacity after UPS starts at AC mode. Charger current could be adjusted automatically according to battery capacity selected. (Also charger current is selectable). Via the setting tool, all related parameter settings can be performed. These corresponding settings are done though LCD.



CAUTION!

Ensure correct polarity battery string series connection. i.e. inter-tier and inter block connections are from (+) to (-) terminals. Don't mix batteries with different capacity or different brands, or even mix up new and old batteries, either.



WARNING!

Ensure correct polarity of string end connections to the Battery Circuit Breaker and from the Battery Circuit Breaker to the UPS terminals i.e. (+) to (+) / (-) to (-) but disconnect one or more battery cell links in each tier. Do not reconnect these links and do not close the battery circuit breaker unless authorized by the commissioning engineer.

3.9 UPS Multi—Module Installation

The basic installation procedure of a parallel system comprising of two or more UPS modules is the same as that of single module system. The following sections introduce the installation procedures specified to the parallel system.

3.9.1 Cabinet installation

Connect all the UPSes needed to be put into parallel system as below picture.

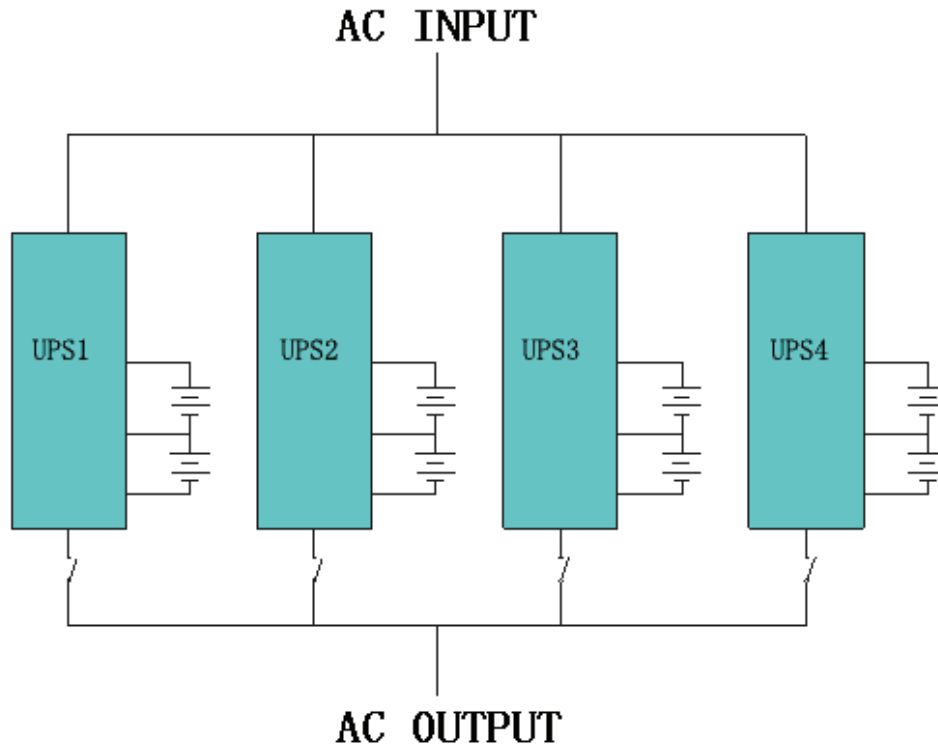

Make sure each UPS input breaker is in "off" position and there is no any output from each UPS connected. Battery groups can be connected separately or in parallel, which means the system itself provides both separate battery and common battery.



WARNING!

Make sure the N、L lines are correct, and grounding is well connected.

3.9.2 Parallel cable installation

Shielded and double insulated control cables available must be interconnected in a ring configuration between UPS modules as shown below. The parallel control board is mounted on each UPS module. The ring configuration ensures high reliability of the control.

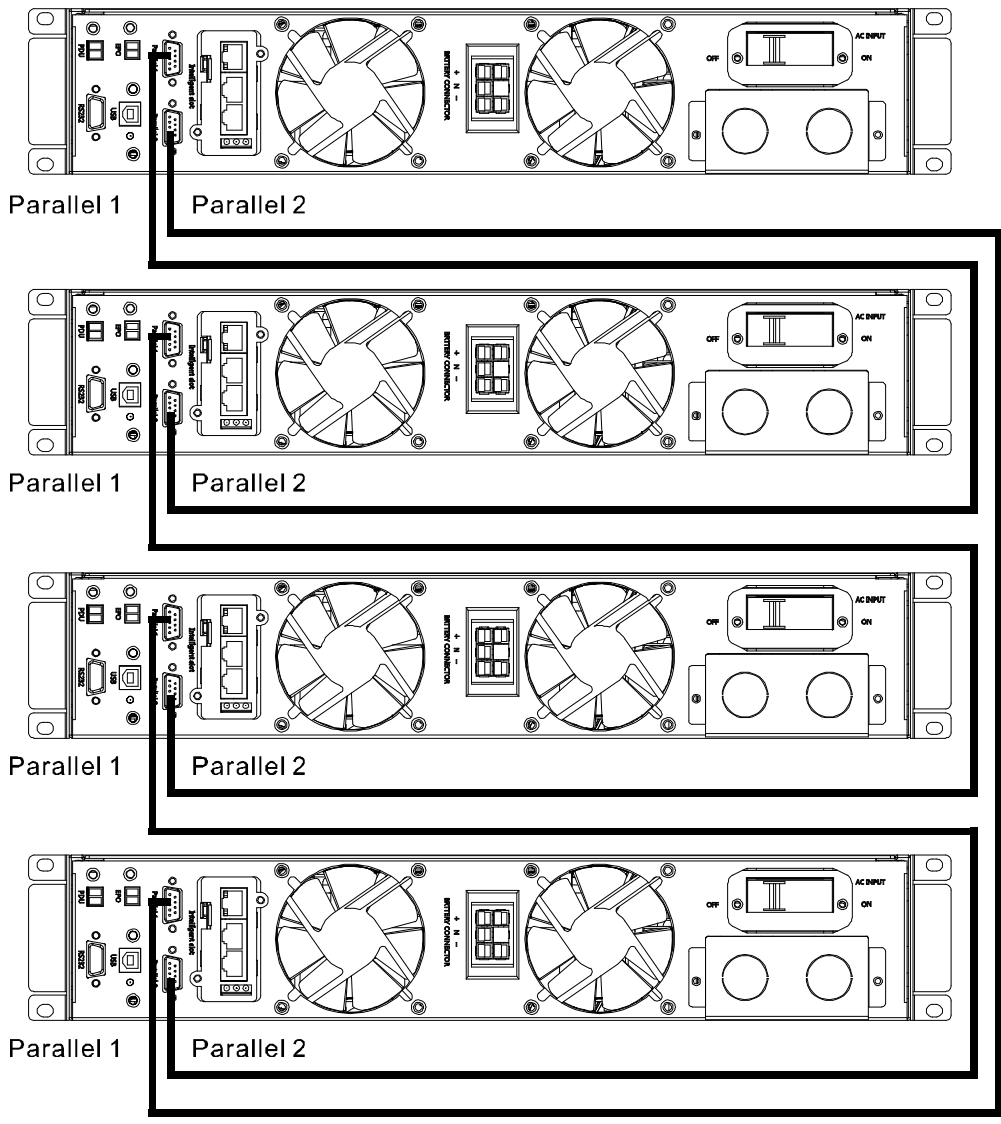

3.9.3 Requirement for the parallel system

A group of paralleled modules behave as one large UPS system but with the advantage of presenting higher reliability. In order to assure that all modules are equally utilized and comply with relevant wiring rules, please follow the requirements below:

- 1) All UPS must be of the same rating and be connected to the same bypass source.
- 2) The Bypass and the Main input sources must be referenced to the same neutral potential.
- 3) The outputs of all the UPS modules must be connected to a common output bus.
- 4) The length and specification of power cables including the bypass input cables and the UPS output cables should be the same. This facilitates load sharing when operating in bypass mode.

4. Operation

4.1 Operation Modes

The UPS is a double-conversion on-line UPS that may operate in the following alternative modes:

◆ Normal mode

The rectifier/charger derives power from the AC Mains and supplies DC power to the inverter while floating and boosting charge the battery simultaneously. Then, the inverter converts the DC power to AC and supplies to the load.

◆ Battery mode (Stored Energy Mode)

If the AC mains input power fails, the inverter, which obtains power from the battery, supplies the critical AC load. There is no power interruption to the critical load. The UPS will automatically return to Normal Mode when AC recovers.

◆ Bypass mode

If the inverter is out of order, or if overload occurs, the static transfer switch will be activated to transfer the load from the inverter supply to bypass supply without interruption to the critical load. In the event that the inverter output is not synchronized with the bypass AC source, the static switch will perform a transfer of the load from the inverter to the bypass with power interruption to the critical AC load. This is to avoid paralleling of unsynchronized AC sources. This interruption is programmable but typically set to be less than an electrical cycle e.g. less than 15ms (50Hz) or less than 13.33ms (60Hz).

◆ ECO Mode

When the UPS is at AC Mode and the requirement to the load is not critical, the UPS can be set at ECO mode in order to increase the efficiency of the power supplied. At ECO mode, the UPS works at Line-interactive mode, so the UPS will transfer to bypass supply. When the AC is out of set window, the UPS will transfer from bypass to Inverter and supplies power from the battery, then the LCD shows all related information on the screen.

◆ Parallel redundancy mode (system expansion)

To achieve a higher capacity and / or increase reliability, the outputs of up to four UPS modules can be programmed to operate in parallel and the built-in parallel controller in each UPS ensures automatic load sharing.

4.2 Turn on/off UPS

4.2.1 Connecting with Utility



CAUTION!

MAKE SURE GROUNDING IS PROPERLY DONE!

- ◆ Set the Battery Breaker to the “ON” position according to the user’s manual.
- ◆ Switch on the UPS



CAUTION!

Check to see if the load is safely connected with the output of the UPS. If the load is not ready to receive power from the UPS, make sure that it is safely isolated from the UPS output terminals

The internal fan of the UPS starts spinning, the UPS is performing self-diagnostics until buzzer beeps twice to show the UPS is normal. Then, the UPS goes to bypass supply, Utility LED and Bypass LED turn Green, the inverter is starting up now. When the inverter is checked “normal”, the UPS goes to working mode and the load is supplied by the inverter now.

No matter the UPS is operated normally or not, the LCD display will indicate current status. The top lines display the UPS operational status and the bottom lines indicate alarm conditions when they occur.

4.2.2 Black(Cold) start procedure

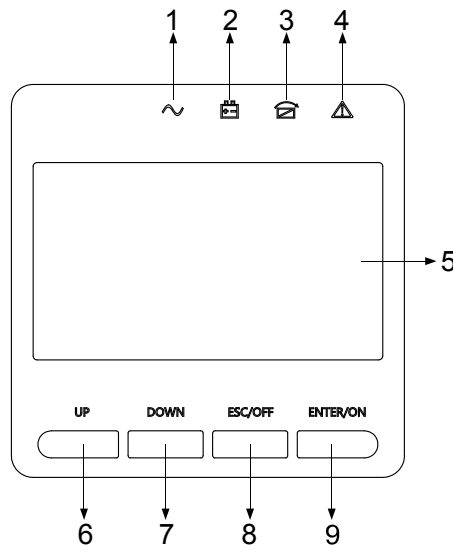

CAUTION!

Follow these procedures when the input AC Utility Failure, but battery is normal

- ◆ Turn on the battery switch.
The battery will feed the Auxiliary power board.
- ◆ Trigger the cold start buttons at the position 9 in above drawing.

When battery normal, rectifier starts operation, 30s later, inverter starts and operates, INV and output light up.



CAUTION!

Wait for approximately 30 seconds before you press the black start key

4.2.3 Inverter Off

When the Utility is normal, press “ESC /OFF” button for approx. 1 sec until beep sounds, the inverter LED will extinguish, the bypass LED on, then the UPS turns to bypass supply.

When the UPS is on battery mode or without AC, press “ESC /OFF” button for approx. 1 sec until beep sounds, the output of the UPS is off, fan stop spinning. After 60 seconds, all the LED on the LCD display extinguish.

4.2.4 Disconnecting with Utility



CAUTION!

This procedure should be followed to completely shut down the UPS and the LOAD. After all power switches, isolators and circuit breakers are opened, there will be no output.

- ◆ After the inverter is off, turn the Utility and battery breakers to “OFF”, then the LCD display will extinguish completely and fan stops spinning in 60 seconds. If there are external battery packs connected, please also turn the battery breaker to “OFF”.



WARNING!

Wait for about 5 minutes for the internal D.C. bus bar capacitors to be completely discharged.

4.3 LCD Display instruction

NOTICE! The display provides more functions than those described in this manual. There are 10 interfaces available in the LCD display:

ITEM	Interface Description	Content Displayed
01	Input	Voltage & Frequency
02	Output	Voltage & Frequency
03	Bat. +	Voltage & Current
04	Bat. -	Voltage & Current
05	Temperature	PFC/Internal temperature and ambient temperature
06	Load	Load
07	Bus voltage	Bus voltage \pm
08	Software version	DSP version of inverter software
09	Model	Model

1. When the UPS is connecting with the Utility or Battery at cold start mode, it shows as drawing below:

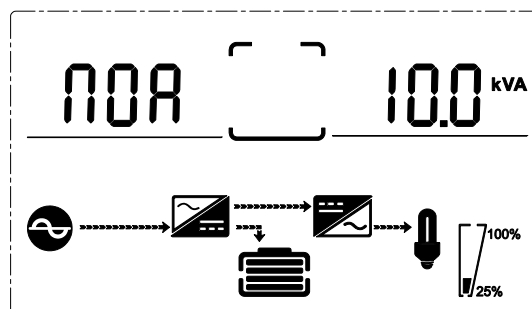

(1) Operational Status and mode

1) Operational Status and mode When the UPS at single mode, it shows “NOA” or “ECO” or “CF”, but If the UPS at parallel mode, it shows “PAL” instead.

2) Press “DOWN” button, the UPS goes to next page as shown below.

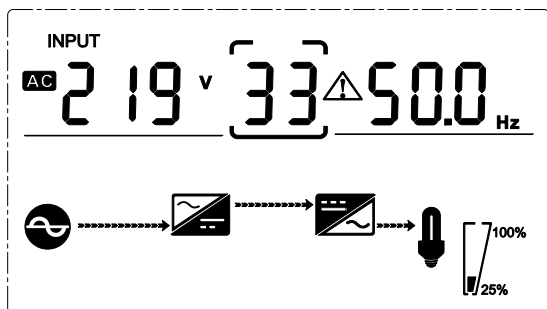

(2) Input voltage

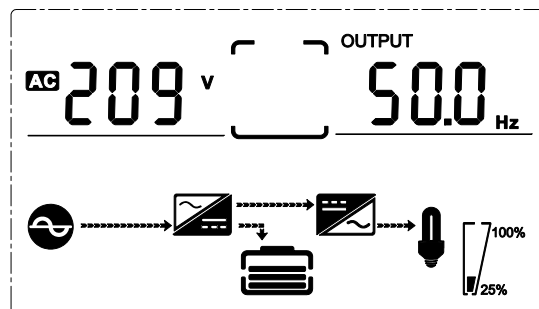

(3) Output voltage

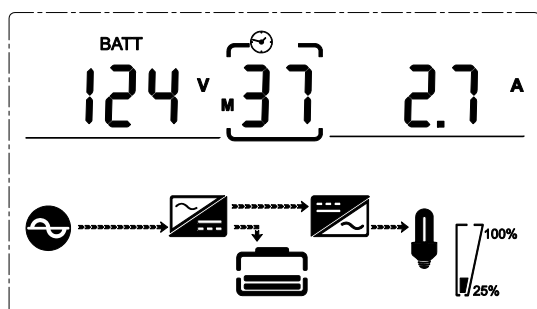

(4) Bat + voltage (Positive)

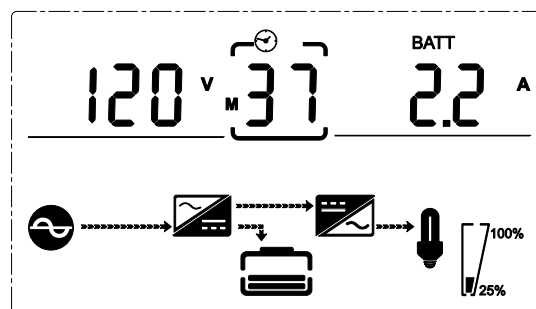

(5) Bat - voltage (Negative)

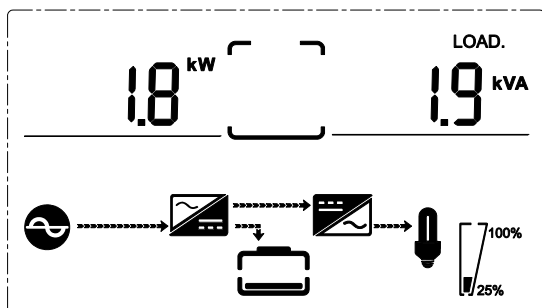

(6) Load

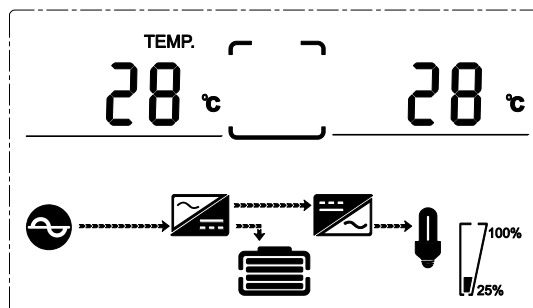

(7) PFC/ Ambient temperature up, only shows the high temperature Internal temperature (down)

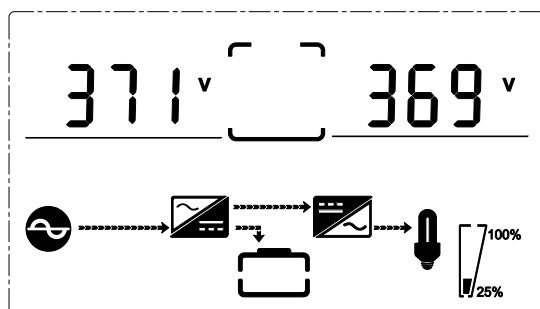

(8) Bus voltage

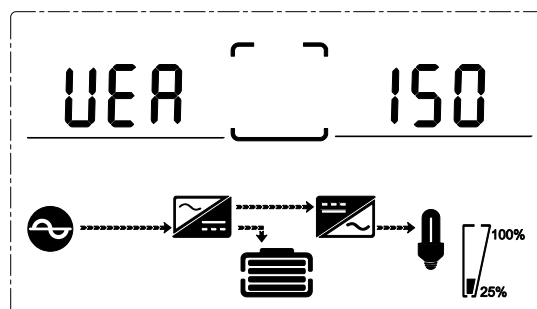

(9) Software version

4.4 Parameters setting

The setting function is controlled by 4 buttons (ENTER/ON, ESC/OFF, UP, DOWN): ENTER --- goes into the setting page and value adjustment; UP & DOWN --- for choosing different pages.

After the UPS turn ON, press buttons UP & DOWN for 3 seconds and then goes into the setting interface page. After finishing setting the parameter, press “ESC/OFF” button until exiting out of the current interface.

4.4.1 Mode setting

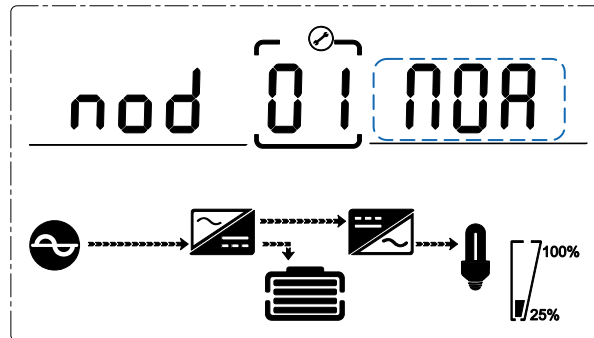

Mode setting (Note: Inside the broken-line is the flashing part.)

After ENTERing the setting menu, it's mode setting defaulted, and the mode setting line flashing as in above picture.

- Use button ENTER /ON to choose different mode. There are 4 different modes for setting: ECO, PAL, NOR,CF.
- Press UP & DOWN to exit the mode setting (save the mode setting), and goes to output voltage setting or parallel redundancy quantity setting.

4.4.2 Output voltage setting

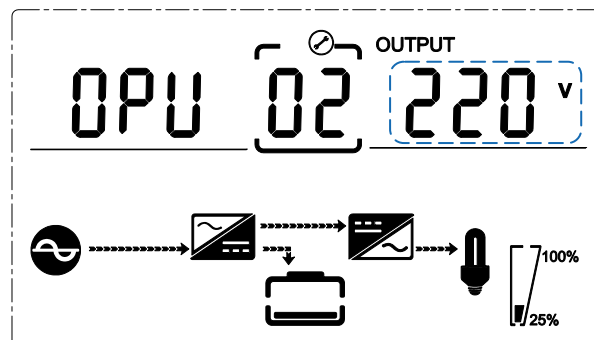

Output voltage setting

(Note: Inside the broken-line is the flashing part.)

When under the mode setting press DOWN or when under frequency setting press UP, it goes to the output voltage setting. The output voltage line flashes as in above picture.

- Use button ENTER/ON to choose the different output voltage. There are 4 different voltages---208,220, 230, 240.

- Press ESC/OFF button to exit the output voltage setting (save the output voltage setting) and goes to mode setting or frequency setting.

NOTE: When powered by inverter, it is necessary to turn off the inverter before setting voltage and frequency level.

4.4.3 Output frequency setting

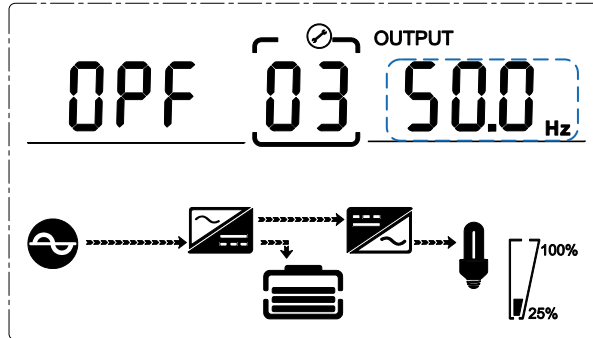

Frequency setting

(Note: Inside the broken-line is the flashing part.)

When under the output voltage setting press DOWN or when under battery capacity setting press UP, it goes to the frequency setting. The frequency line flashes as in above picture.

- Use button ENTER/ON to choose the different frequency. There are 2 different frequency---50/60Hz.
- Press ESC/OFF button to exit the frequency setting (save the frequency setting) and goes to output voltage setting or battery capacity setting.

Note: When powered by inverter, it is necessary to turn off the inverter before setting voltage and frequency level.

4.4.4 Battery capacity setting

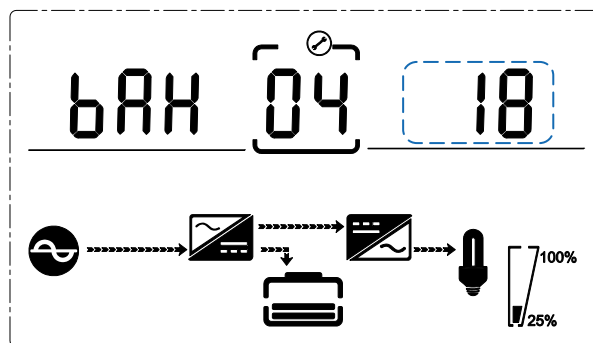

Battery capacity setting

(Note: Inside the broken-line is the flashing part.)

When under the frequency setting press DOWN or when under battery quantity setting press UP, it goes to the battery capacity setting. The battery capacity line flashes as in above picture.

- Use button ENTER/ON to choose the different battery capacity. Battery capacity range is 1-200Ah. (Note: long-press of UP or DOWM can adjustment battery capacity quickly.)
- Press ESC/OFF button to exit the battery capacity setting (save the capacity setting) and goes to frequency setting or battery quantity setting.

4.4.5 Battery quantity setting

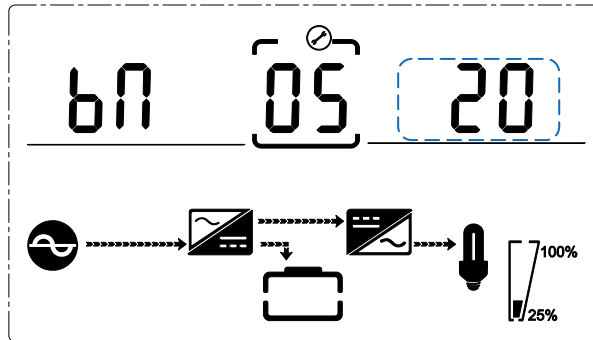

Battery quantity setting

(Note: Inside the broken-line is the flashing part.)

When under the battery capacity setting press DOWN or when under bypass voltage upper limit setting press UP, it goes to the battery quantity setting. The battery quantity line flashes as in above picture.

- Use button ENTER/ON to choose the different battery quantity. Battery quantity range is 16、18、20.
- Press ESC/OFF button to exit the battery quantity setting (save the battery quantity setting) and goes to battery capacity setting or bypass voltage upper limit setting.

4.4.6 Bypass Volt-Hi setting

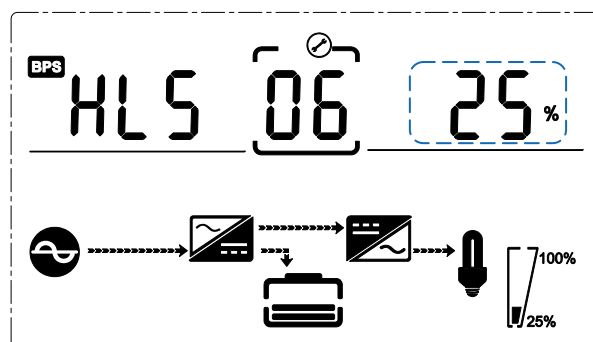

Bypass voltage upper limit setting

(Note: Inside the broken-line is the flashing part.)

When under the battery quantity setting press DOWN or when under bypass voltage lower setting press UP, it goes to the bypass upper limit setting. The bypass upper limit line flashes as in above picture.

- Use button ENTER/ON to set the different bypass voltage upper limit. The bypass voltage upper limit range is 5%,10%,15%,25%(25% only for 220V output).

- Press ESC/OFF button to exit the bypass voltage upper limit setting (save the bypass voltage upper limit setting) and goes to battery quantity setting or bypass voltage lower limit setting.

4.4.7 Bypass Volt-Lo setting

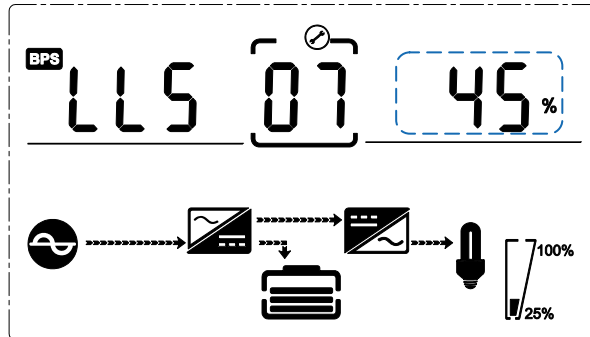

Bypass voltage lower limit setting

(Note: Inside the broken-line is the flashing part.)

When under the bypass voltage upper limit setting press DOWN or when under parallel ID setting press UP, it goes to the bypass lower limit setting. The bypass lower limit line flashes as in above picture.

- Use button ENTER/ON (to set the different bypass voltage lower limit. The bypass voltage lower limit range is 20%,30%,45%.
- Press ESC/OFF button to exit the bypass voltage lower limit setting (save the bypass voltage lower limit setting) and goes to bypass upper limit setting or parallel ID setting.

4.4.8 Buzzer Mute Setting

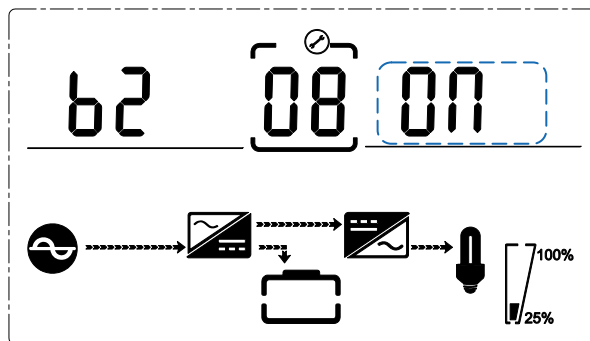

Buzzers mute setting (Note: flashing part in dashed box)

Press DOWN under bypass voltage lower limit setting or press UP under the parallel ID setting can ENTER the buzzer setting. Now the setting status is flashing as the Figure shows (note: on=mute; off= no mute). When press, it shows the mute cycle setting, the selection includes ON and OFF. (Press the up button or down button can exit the mute setting (save the mute setting status) and switch to bypass voltage lower limit setting or parallel ID setting (note: when in stand-alone mode, press down button to exit and save the settings, then the settings is completed for stand-alone unit).

4.4.9 Battery Test Setting

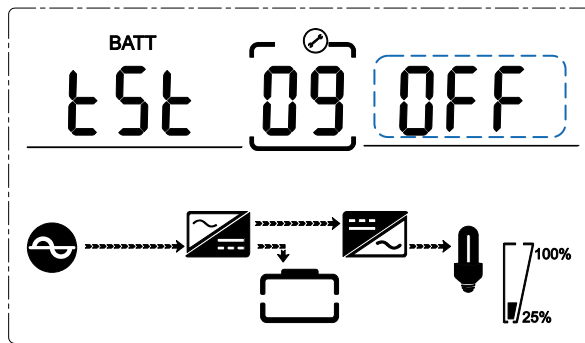

Battery self-test setting

This page is the introduction to the Battery self-test setting. The default Settings is “OFF” when the UPS has no need of the battery self-test function. When turn to “ON”, batteries can do the self-test automatically per 30 days. Three kinds of Battery Self-test Time can be chose as below.

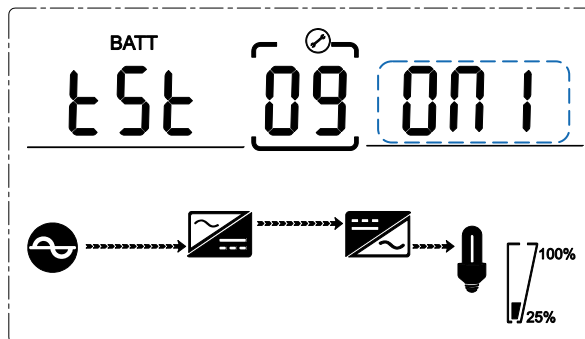

When choosing On1, UPS can transfer to Battery Mode automatically per 30 days. And the Battery Self-test Time is 10 seconds.

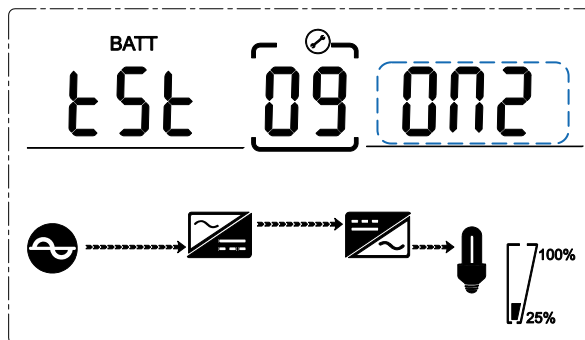

When choosing On2, UPS can transfer to Battery Mode automatically per 30 days. And the Battery Self-test Time is 10 minutes.

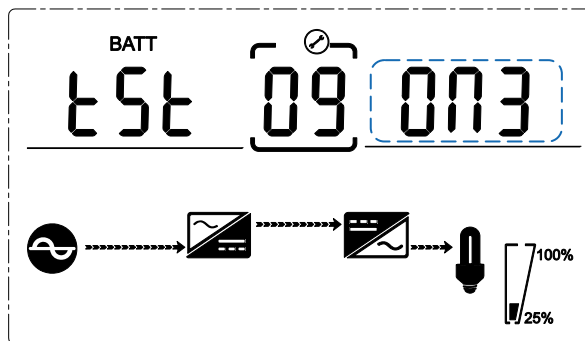

When choosing On3, UPS can transfer to Battery Mode automatically per 30 days. And the Battery Self-test Time is EOD.

4.4.10 Parallel ID setting

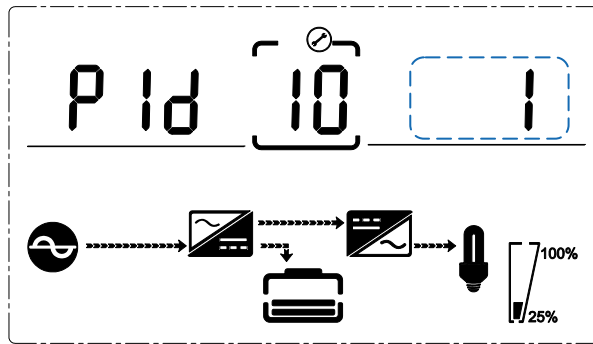

Parallel ID setting

(Note: Inside the broken-line is the flashing part.)

When under the bypass voltage lower limit setting press DOWN or when under parallel quantity setting press UP, it goes to the parallel ID setting. The parallel ID flashes as in above picture.

- Use button ENTER/ON to set the different parallel ID. The parallel ID range is 1~4.
- Press ESC/OFF button to exit the parallel ID setting (save the parallel ID setting) and goes to bypass lower limit setting or parallel quantity setting.

NOTICE! Parallel cable cannot be connected when setting the parallel parameters.

4.4.11 Parallel quantity setting

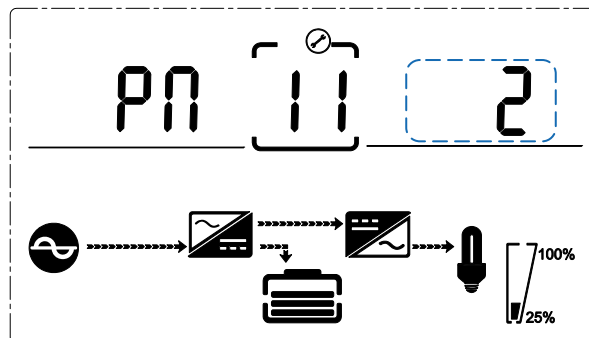

Parallel quantity setting

(Note: Inside the broken-line is the flashing part.)

When under the parallel ID setting press DOWN or when under parallel redundancy quantity setting press UP, it goes to the parallel quantity setting. The parallel quantity flashes as in above picture.

- Use button ENTER/ON to set the parallel quantity. The parallel quantity range is 2~4.
- Press ESC/OFF button to exit the parallel quantity setting (save the parallel quantity setting) and goes to parallel ID setting or parallel redundancy quantity setting.

4.4.12 Parallel redundancy quantity setting

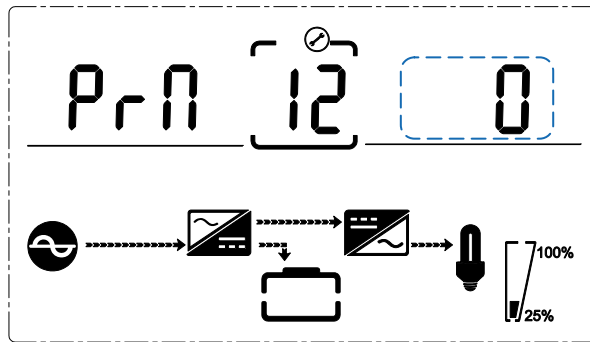

Parallel redundancy quantity setting

(Note: Inside the broken-line is the flashing part.)

When under the parallel quantity setting press DOWN, it goes to the parallel redundancy quantity setting. The parallel redundancy quantity flashes as in above picture.

- Use button ENTER/ON to set the parallel redundancy quantity. The parallel redundancy quantity range is 0~1
- Press UP& DOWN to go to parallel quantity setting, or ESC/OFF button to exit the mode setting. Then UPS LCD panel setting is accomplished.

Appendix 1 Specifications

Capacity		6kVA/5.4kW	10kVA/9kW
Type		6kVA; 10kVA	
input	Input mode	Single phase + Ground	
	Power factor	≥ 0.99	
	rating voltage	208/220/230/240Vac (can be set)	
	rating frequency	50Hz/60Hz (auto sensing)	
	Voltage range	120~276Vac	
	Frequency range	45~55Hz/54~66Hz	
	Bypass voltage range	220Vac max: 10%, 15%, 20% or 25%, default : 25%	
		230Vac max: 10%, 15% or 20%, default +20%	
	Bypass frequency range	240Vac max: +10% or 15%, default +15%	
		min: 20%, 30% or 45%, default 45%	
Bypass frequency range	$\pm 1\%$ 、 $\pm 2\%$ 、 $\pm 4\%$ 、 $\pm 5\%$ 、 $\pm 10\%$		
THDI	$\leq 3\%$ (100% linear load, input THDV $\leq 1\%$)		
	$\leq 5\%$ (100% non liner load, input THDV $\leq 1\%$)		
battery	Battery number	16/18/20pcs (can be set)	
	Battery type	VRLA	
	Charge model	Boost charge or float charge auto switch	
	Charge time	Boost charge up to 20Hr(Max)	
	Charge current(A)	1A (S) /10A (H)	
output	Output type	Single phase + Ground	
	Output precision	$\pm 1.0\%$;	
	Voltage distortion (THD)	$\leq 2\%$ at 100% liner load	
		$\leq 5\%$ at 100% non-liner load	
	Rating voltage	208/220/230V/240Vac	
	Frequency precision	$\pm 0.1\%$	
	Rating Frequency	50Hz/60Hz	
	Frequency track speed	1Hz/s	
	Overload	105%~110%, 1Hr	
		110%~125% 10min	
		125%~150% 1min	
		$\geq 150\%$ 200ms	
	Peak value factor	3:1	
	Efficiency at normal	$\geq 93\%$	
Dynamic respond	5.0%		
	20ms		
DC heft	$\leq 500\text{mV}$		
Switch time	Between Normal mode and battery mode	0ms	
	Between inverter and bypass	0ms	
		unlock: $< 15\text{ms}$ (50Hz), $< 13.33\text{ms}$ (60Hz)	

Norse	<55dB (1m)
Display	LCD+LED
Safety	Meeting IEC62040-1 GB4943。
Max input voltage	320Vac, 1Hr
EMI	Conduction : IEC 62040-2
	Radiation : IEC 62040-2
	Harmonics : IEC 62040-2
EMS	IEC 62040-2
MTBF	250,000Hr 1+1 400,000Hr
MTTR	30min
Isolation resistance	> 2M Ω (500Vdc)
Isolation intension	2820Vdc, <3.5mA, 1min
Surge	Meeting IEC60664-1 1.2/50uS+8/20uS 6kV/3kA.
Protection	IP20
Parallel circumfluence	1+1 \leq 8%, N+1 \leq 3%
Parallel equal current	1+1 \leq 8%, N+1 \leq 10%

Appendix 2 Communication port definition

USB communication port

1	2
4	3

Definition of Male port:

Pin 1 VCC , Pin 2 D-
pin 3 D+ , Pin 4 GND

Application: use UPSilon2000 Power Management software

Available functions of the USB

- Monitor UPS power status
- Monitor UPS alarm info
- Monitor UPS running parameters
- Timing off/on setting

Appendix 3 Option

1. Dry contact card
2. SNMP card
3. Parallel card

Appendix 4 UPS message table

This section lists the alarm messages that the UPS might display. This section is listed with each alarm message to help you troubleshoot problems .

4.1 Alarm Information

Item	UPS Alarm Warning	Buzz	LED
1	Rectifier Fault	Beep continuously	Fault LED lit
2	Inverter fault(Including Inverter bridge is shorted)	Beep continuously	Fault LED lit
3	Inverter Thyristor short	Beep continuously	Fault LED lit
4	Inverter Thyristor broken	Beep continuously	Fault LED lit
5	Bypass Thyristor short	Beep continuously	Fault LED lit
6	Bypass Thyristor broken	Beep continuously	Fault LED lit
7	Fuse broken	Beep continuously	Fault LED lit
8	Parallel relay fault	Beep continuously	Fault LED lit
9	Fan fault	Beep continuously	Fault LED lit
10	Reserve	Beep continuously	Fault LED lit
11	Auxiliary power fault	Beep continuously	Fault LED lit
12	Initialization fault	Beep continuously	Fault LED lit
13	P-Battery Charger fault	Beep continuously	Fault LED lit
14	N-Battery Charger fault	Beep continuously	Fault LED lit
15	DC Bus over voltage	Beep continuously	Fault LED lit
16	DC Bus below voltage	Beep continuously	Fault LED lit
17	DC bus unbalance	Beep continuously	Fault LED lit
18	Soft start failed	Beep continuously	Fault LED lit
19	Rectifier Over Temperature	Twice per second	Fault LED lit
20	Inverter Over temperature	Twice per second	Fault LED lit
21	Reserve	Twice per second	Fault LED lit
22	Battery reverse	Twice per second	Fault LED lit
23	Cable connection error	Twice per second	Fault LED lit
24	CAN comm. Fault	Twice per second	Fault LED lit
25	Parallel load sharing fault	Twice per second	Fault LED lit
26	Battery over voltage	Once per second	Fault LED blinking
27	Mains Site Wiring Fault	Once per second	Fault LED blinking
28	Bypass Site Wiring Fault	Once per second	Fault LED blinking
29	Output Short-circuit	Once per second	Fault LED blinking
30	Rectifier over current	Once per second	Fault LED blinking
31	Bypass over current	Once per second	BPS LED blinking
32	Overload	Once per second	INV or BPS blinking
33	No battery	Once per second	BATTERY blinking

Item	UPS Alarm Warning	Buzz	LED
34	Battery under voltage	Once per second	BATTERY blinking
35	Battery low pre-warning	Once per second	BATTERY blinking
36	Internal Communication Error	Once per second	Bypass LED lit
37	DC component over limit.	Once per 2 seconds	INV blinking
38	Parallel Overload	Once per 2 seconds	INV blinking
39	Mains volt. Abnormal	Once per 2 seconds	BATTERY LED lit
40	Mains freq. abnormal	Once per 2 seconds	BATTERY LED lit
41	Bypass Not Available		BPS blinking
42	Bypass unable to trace		BPS blinking
43	Inverter on invalid		
45	EPO	Beep continuously	Fault LED lit